

SURGICAL INSTRUMENTS



INTRODUCING OURSELVE

Manufacturer of surgical implants and medical devices. Solutions for patient orthopaedic and osteosyntheses fracture treatments, osteosyntheses customized orthopaedic innovations and solutions.

CORPORATE COMPANY PHILOSOPHY, SOLUTION WITHOUT COMPROMISE

MAT GmbH & Co.KG. design, develop and manufacture implants and instruments for use in specific treatments of trauma orthopedic systems, fracture reconstruction treatment systems.

- Plate- and screw systems (mini, small- and large fragment systems)
- Locking plate- and screw systems (small- and large fragment systems)
- Interlocking nailing systems
- Cranio maxillo facial plate- and screw systems
- Cannulated screw system
- Flexible reamer systems
- Hand and Foot implants (screws- and staple systems)
- External fixator systems
- Oscillating saw blades
- Power tool systems, battery- and air drive systems
- General surgical instruments
- Hemi arthroplasty instruments for hip surgeries and cement extraction



MAT GmbH & Co.KG. innovative and exiting product portfolio is updated and expanded in line with technological advances to satisfy the current and future needs of both, patients and healthcare professionals. MAT GmbH & Co.KG. is committed to playing our part in achieving improved healthcare outcomes worldwide.

Scalpel Handles

Forceps

Dressing & Tissue Forceps

Scissors

Needle Holders

Retractors

Orthopedic

Contents

Special Note

MAT is carrying the full range of over 15.000 different Surgical Instruments.

Please do not hesitate to contact us for any Instruments which you do not find in this catalogue.

SCALPEL HANDLES



Standard

INS-10-0231-03

No.3
Solid



INS-10-0231-05

No.3
Solid, with scale



INS-10-0231-04

No.3
Solid



INS-10-0213-04

No.3
Plastics



INS-10-0234-31

No.3L
Solid straight

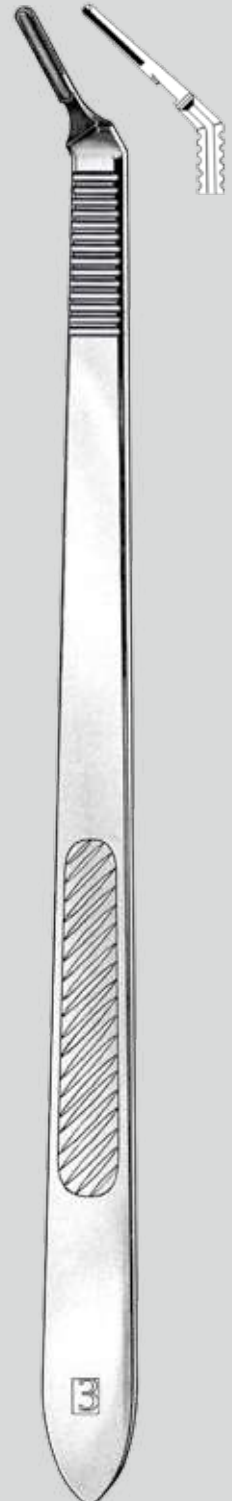

INS-10-0234-35

No.3L
Solid angled

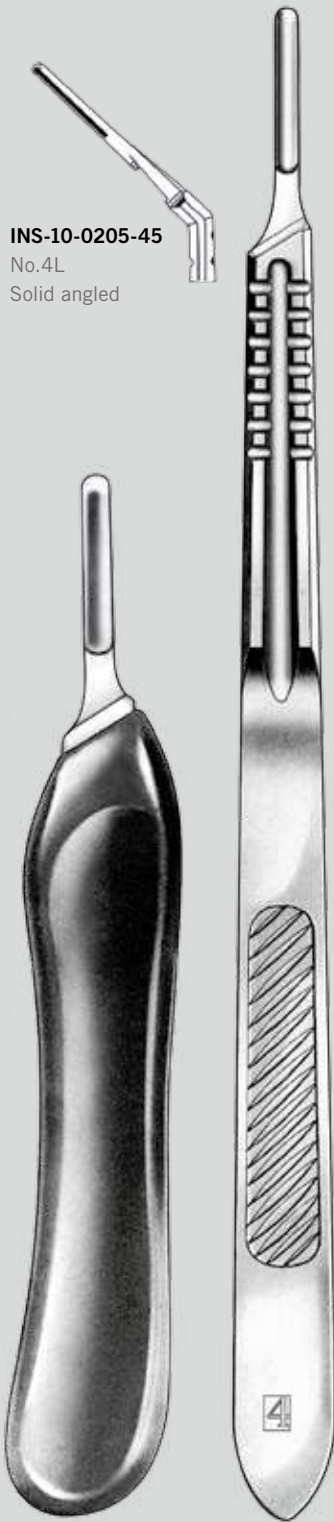

INS-10-0205-45
No.4L
Solid angled

Standard

INS-10-0201-04
No.4
Solid

INS-10-3001-00
No.4
Graduated in mm

INS-10-0243-03
No.4
Plastics

INS-10-0205-41
No.4L
Solid straight

INS-10-3005-00
No.7
Long

INS-10-0238-07
No.7
Solid

INS-10-0238-71
No.7K
Solid

INS-10-3010-00
No.5
Solid



Kelly



INS-13-0431-14 14 cm / 5½" **INS-13-0432-14**
Straight Curved

Kelly-Rankin



INS-13-0435-16 16 cm / 6¼" **INS-13-0436-16**
INS-13-3080-18 18 cm / 7" **INS-13-3081-18**
Straight Curved

Crile



INS-13-0441-14 14 cm / 5½" **INS-13-0442-14**

INS-13-3085-14 14 cm / 5½" **INS-13-3086-14**
1:2 Teeth 1:2 Teeth

Crile-Rankin



INS-13-0447-16 16 cm / 6¼" **INS-13-0448-16**
INS-13-3095-18 18 cm / 7" **INS-13-3096-18**

INS-13-3090-16 16 cm / 6¼" **INS-13-3091-16**
INS-13-3097-18 18 cm / 7" **INS-13-3098-18**
1:2 Teeth 1:2 Teeth

Kelly
Delicate

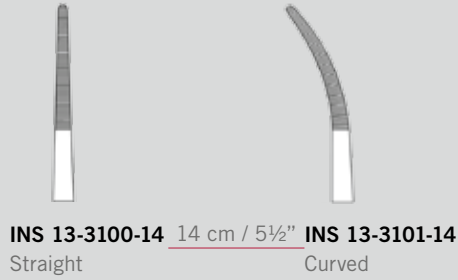

Kelly-Rankin
Delicate

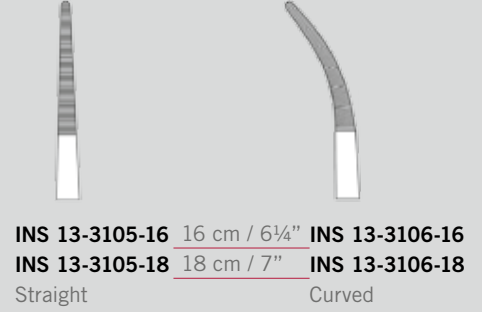

Crile
Delicate

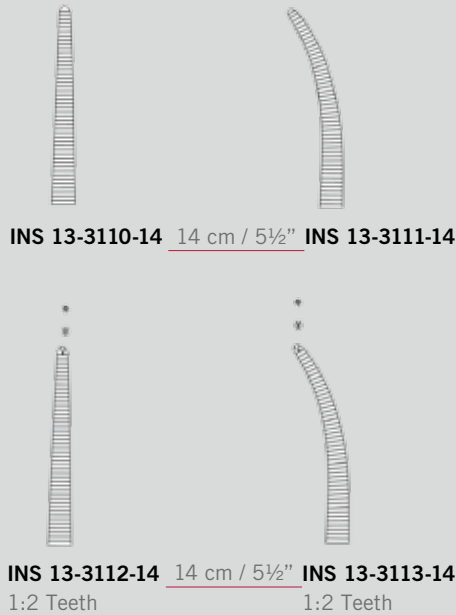

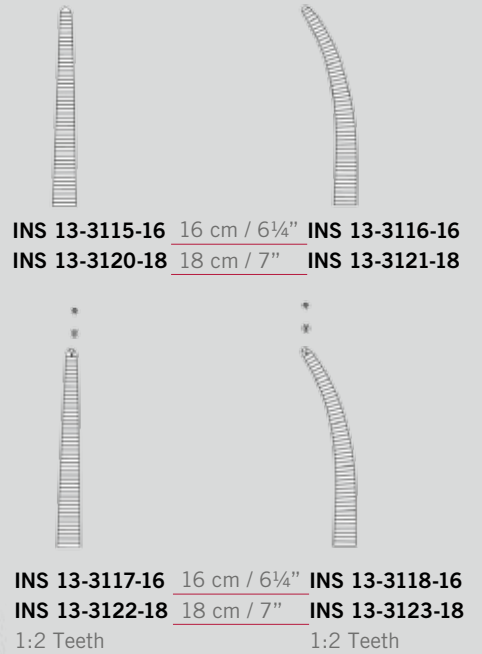

Crile-Rankin
Delicate



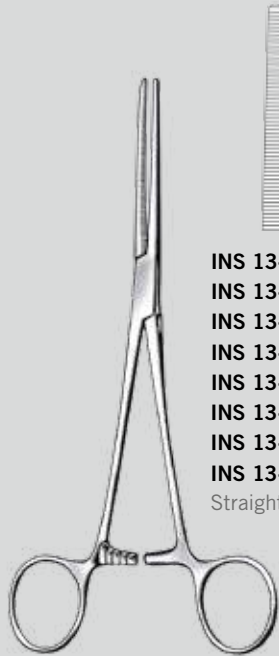

Rochester-Pean



		
INS 13-0511-14	<u>14 cm / 5½"</u>	INS 13-0512-14
INS 13-0511-16	<u>16 cm / 6¼"</u>	INS 13-0512-16
INS 13-0511-18	<u>18 cm / 7"</u>	INS 13-0512-18
INS 13-0511-20	<u>20 cm / 8"</u>	INS 13-0512-20
INS 13-0511-22	<u>22 cm / 8¾"</u>	INS 13-0512-22
INS 13-0511-24	<u>24 cm / 9½"</u>	INS 13-0512-24
INS 13-0511-26	<u>26 cm / 10½"</u>	INS 13-0512-26
INS 13-0511-30	<u>30 cm / 12"</u>	INS 13-0512-30
Straight		Curved

Rochester-Ochsner





		
INS 13-0515-14	<u>14 cm / 5½"</u>	INS 13-0516-14
INS 13-0515-16	<u>16 cm / 6¼"</u>	INS 13-0516-16
INS 13-0515-18	<u>18 cm / 7"</u>	INS 13-0516-18
INS 13-0515-20	<u>20 cm / 8"</u>	INS 13-0516-20
INS 13-0515-22	<u>22 cm / 8¾"</u>	INS 13-0516-22
INS 13-0515-24	<u>24 cm / 9½"</u>	INS 13-0516-24
INS 13-0515-26	<u>26 cm / 10½"</u>	INS 13-0516-26
INS 13-0515-30	<u>30 cm / 12"</u>	INS 13-0516-30
Straight		Curved

Rochester-Pean

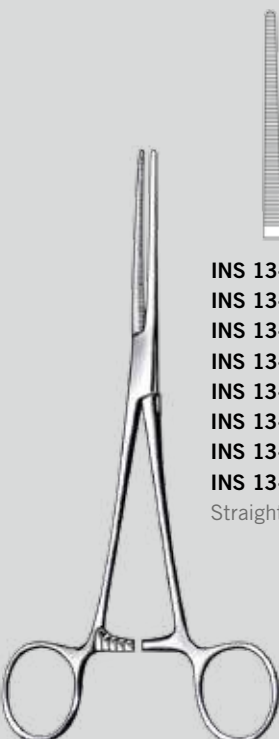
Delicate





		
INS 13-3186-14	<u>14 cm / 5½"</u>	INS 13-3187-14
INS 13-3186-16	<u>16 cm / 6¼"</u>	INS 13-3187-16
INS 13-3186-18	<u>18 cm / 7"</u>	INS 13-3187-18
INS 13-3186-20	<u>20 cm / 8"</u>	INS 13-3187-20
INS 13-3186-22	<u>22 cm / 8¾"</u>	INS 13-3187-22
INS 13-3186-24	<u>24 cm / 9½"</u>	INS 13-3187-24
INS 13-3186-26	<u>26 cm / 10½"</u>	INS 13-3187-26
INS 13-3186-30	<u>30 cm / 12"</u>	INS 13-3187-30
Straight		Curved

Rochester-Ochsner

Delicate



		
INS 13-3190-14	<u>14 cm / 5½"</u>	INS 13-3191-14
INS 13-3190-16	<u>16 cm / 6¼"</u>	INS 13-3191-16
INS 13-3190-18	<u>18 cm / 7"</u>	INS 13-3191-18
INS 13-3190-20	<u>20 cm / 8"</u>	INS 13-3191-20
INS 13-3190-22	<u>22 cm / 8¾"</u>	INS 13-3191-22
INS 13-3190-24	<u>24 cm / 9½"</u>	INS 13-3191-24
INS 13-3190-26	<u>26 cm / 10½"</u>	INS 13-3191-26
INS 13-3190-30	<u>30 cm / 12"</u>	INS 13-3191-30
Straight		Curved

Pean-Nippon



INS-13-3193-14 14.5 cm / 5¾" INS-13-3194-14
 INS-13-3193-16 16.5cm / 6½" INS-13-3194-16
 INS-13-3193-18 18.5cm / 7¼" INS-13-3194-18

Kocher-Nippon



INS-13-3197-14 14.5 cm / 5¾" INS-13-3198-14
 INS-13-3197-16 16.5cm / 6½" INS-13-3198-16
 INS-13-3197-18 18.5cm / 7¼" INS-13-3198-18
 1:2 Teeth 1:2 Teeth

Dixon-Lovelace



INS-13-3200-16 16 cm / 6¼" INS-13-3201-16
 1:2 Teeth

Heiss



INS-13-3203-01 20 cm / 8"

INS-13-3203-02 20 cm / 8" INS-13-3203-03

INS-13-3204-01 20 cm / 8" INS-13-3204-02
 1:2 Teeth 1:2 Teeth

Adson

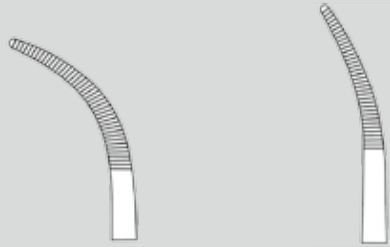

INS-13-3205-18 18 cm / 7" INS-13-3206-18

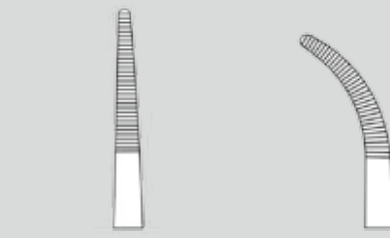

INS-13-3207-18 18 cm / 7" INS-13-3208-18

Rochester-Carmalt

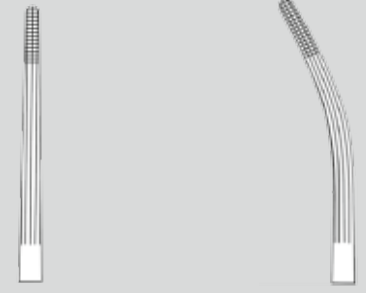
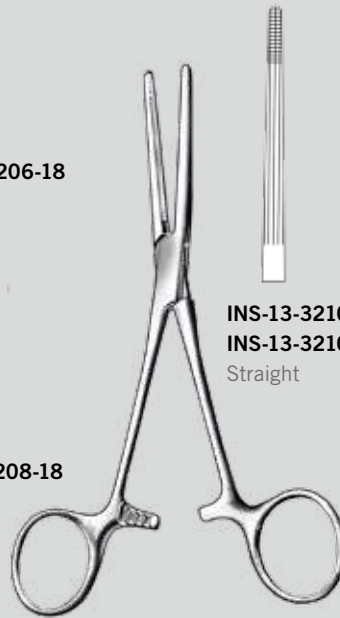

INS-13-3210-16 16 cm / 6¼" INS-13-3211-16

INS-13-3210-20 20 cm / 8" INS-13-3211-20

Straight

Curved

Bengolea



INS-13-3212-20 20 cm / 8" INS-13-3213-20

INS-13-3212-26 26 cm / 10¼" INS-13-3213-26

Straight

Curved



INS-13-3214-20 20 cm / 8" INS-13-3215-20

INS-13-3214-26 26 cm / 10¼" INS-13-3215-26

Straight

Curved

1:2 Teeth

1:2 Teeth

Bainbridge

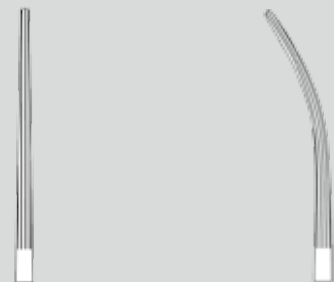

INS-13-3218-15 15 cm / 6" INS-13-3219-15

INS-13-3218-18 18.5 cm / 7¼" INS-13-3219-18

Straight

Curved

Baby-Mixer

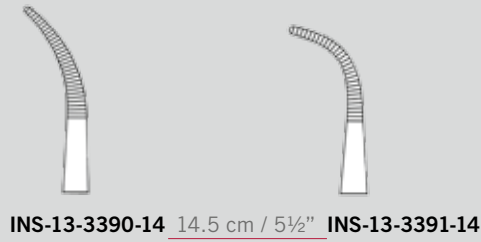

Mixer

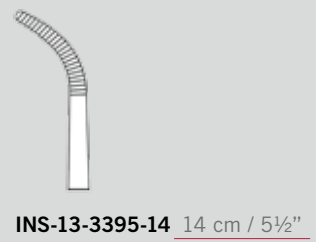
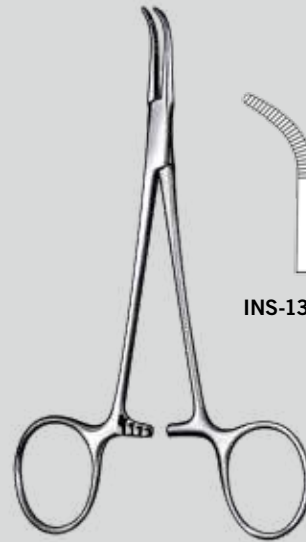

Mixer-Baby

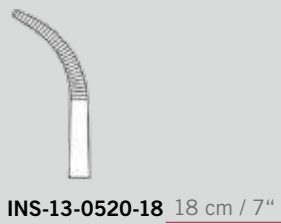

Fergusson

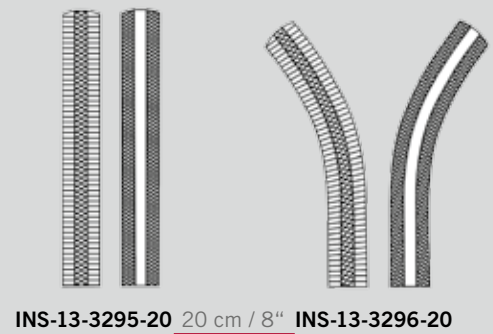
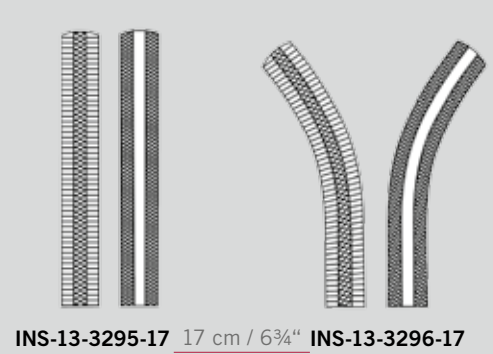

Jones



INS-13-0982-05 5 cm / 2"
INS-13-0982-09 9 cm / 3½"

Schaedel



INS-13-0976-09 9 cm / 3½"

English Model



INS-13-3625-09 9 cm / 3½"

Backhaus

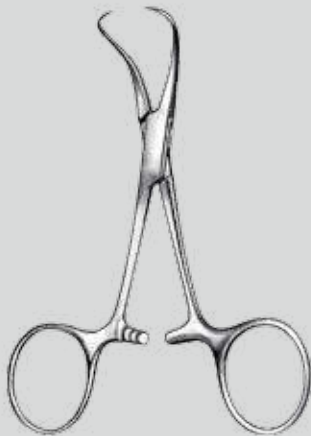

INS-13-1016-09 9 cm / 3½"
INS-13-1016-11 11 cm / 4¼"
INS-13-1016-13 13 cm / 5"
INS-13-1016-15 15 cm / 6"



Roeder

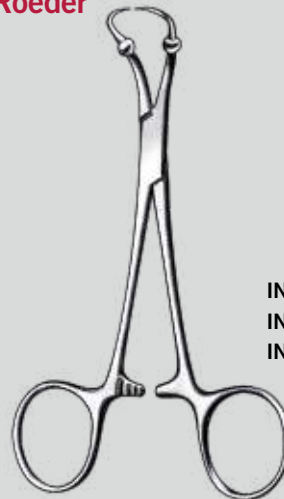

INS-13-3630-11 11 cm / 4¼"
INS-13-3630-13 13 cm / 5"
INS-13-3630-15 15 cm / 6"

Lorna



INS-13-1020-10 10 cm / 4"
INS-13-1020-13 13 cm / 5"



Foerster

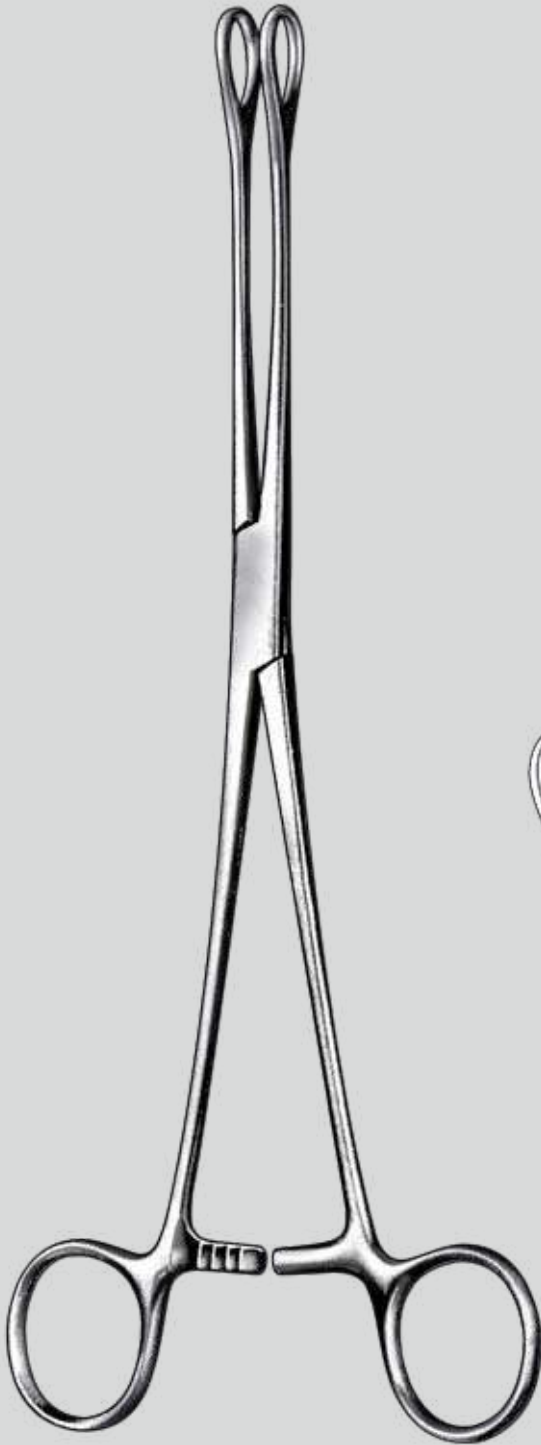

INS-14-3055-25 25 cm / 10"
Smooth jaws

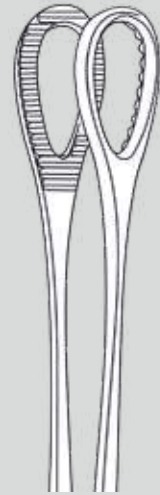

INS-14-3056-18 18 cm / 7"
INS-14-3056-20 20 cm / 8"
INS-14-3056-25 25 cm / 10"

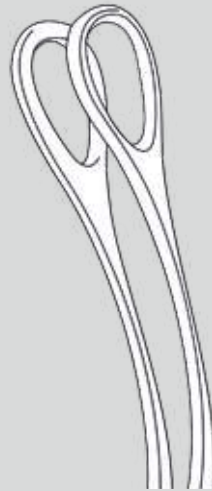

INS-14-3057-25 25 cm / 10"
Smooth jaws

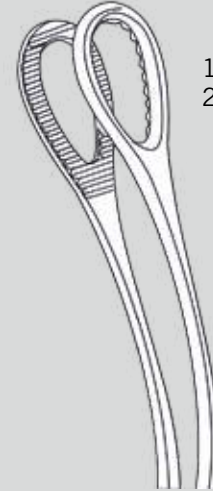

18 cm / 7"
25 cm / 10"

INS-14-3058-18 -
INS-14-3058-20 20 cm / 8"
INS-14-3058-24 -

Adson



INS-12-0269-12 12 cm / 4¾" **INS-12-0469-12**
1:2 Teeth

INS-12-0269-15 15 cm / 6" **INS-12-0469-15**
1:2 Teeth

McIndoe



INS-12-0271-15 15 cm / 6"
Standard

INS-12-2001-15 15 cm / 6"
1:2 Teeth

Standard



INS-12-0201-10 10 cm / 4"	INS-12-0221-10
INS-12-0201-11 11.5 cm / 4½"	INS-12-0221-11
INS-12-0201-13 13 cm / 5"	INS-12-0221-13
INS-12-0201-14 14.5 cm / 5½"	INS-12-0221-14
INS-12-0201-16 16 cm / 6¼"	INS-12-0221-16
INS-12-0201-18 18 cm / 7"	INS-12-0221-18
INS-12-0201-20 20 cm / 8"	INS-12-0221-20
INS-12-0201-23 23 cm / 9"	INS-12-0221-23
INS-12-0201-25 25 cm / 10"	INS-12-0221-25
INS-12-0201-30 30 cm / 12"	INS-12-0221-30

Standard Narrow



Tissue



INS-12-0402-10 10 cm / 4"	INS-12-3020-10
INS-12-0402-11 11.5 cm / 4½"	INS-12-3020-11
INS-12-0402-13 13 cm / 5"	INS-12-3020-13
INS-12-0402-14 14.5 cm / 5½"	INS-12-3020-14
INS-12-0402-16 16 cm / 6¼"	INS-12-3020-16
INS-12-0402-18 18 cm / 7"	INS-12-3020-18
INS-12-0402-20 20 cm / 8"	INS-12-3020-20
INS-12-0402-23 23 cm / 9"	INS-12-3020-23
INS-12-0402-25 25 cm / 10"	INS-12-3020-25
INS-12-0402-30 30 cm / 12"	INS-12-3020-30

1:2 Teeth

Tissue



2:3 Teeth

Micro-Adson



INS-12-0505-12 12 cm / 4¾" **INS-12-3230-12**
With platform



Adson-Brown



INS-12-0501-12 12 cm / 4¾"
7:7 Teeth
INS-12-0501-12-9 12 cm / 4¾"
9:9 Teeth



Iris



INS-12-3235-11 11.5 cm / 4½" **INS-12-3236-11** 11.5 cm / 4½" **INS-12-3237-11**



Feilchenfeld



INS-12-3245-07 7,5 cm / 3"



INS-12-3240-11 11.5 cm / 4½" **INS-12-3241-11** 11.5 cm / 4½" **INS-12-3242-11**
1:2 Teeth 1:2 Teeth 1:2 Teeth



INS-12-3245-09 9 cm / 3½"



INS-12-3245-11 11.5 cm / 4½"



DRESSING & TISSUE FORCEPS

Oehler, TC

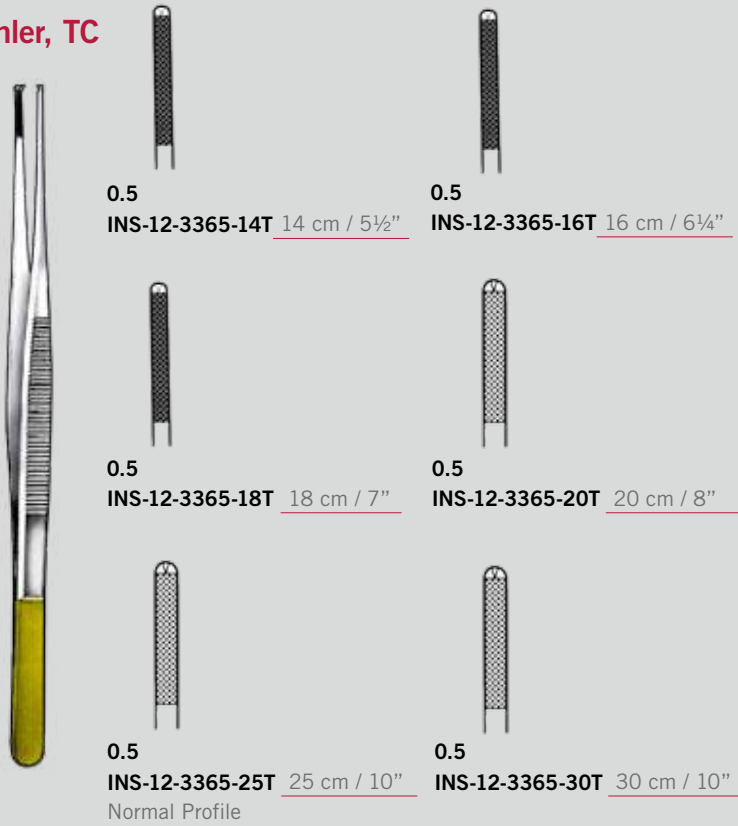

Standard, TC

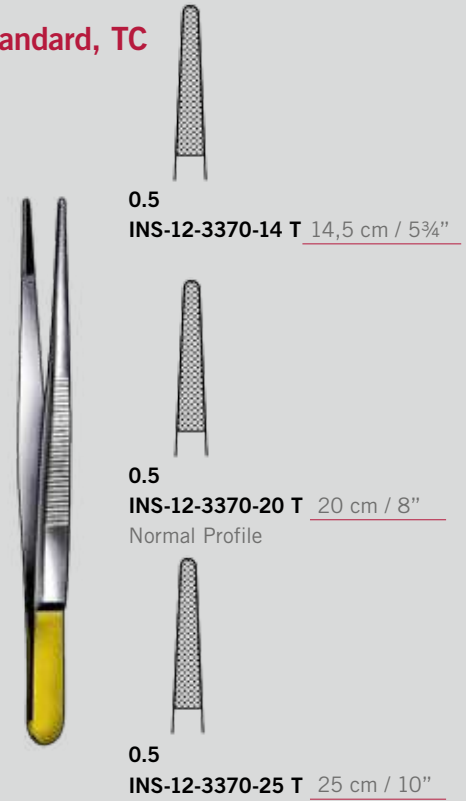

Adson, TC

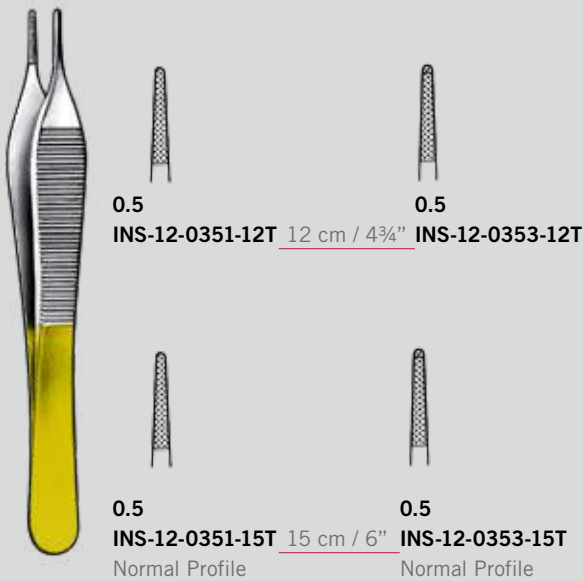

Micro Adson, TC



Adson Brown, TC



Standard

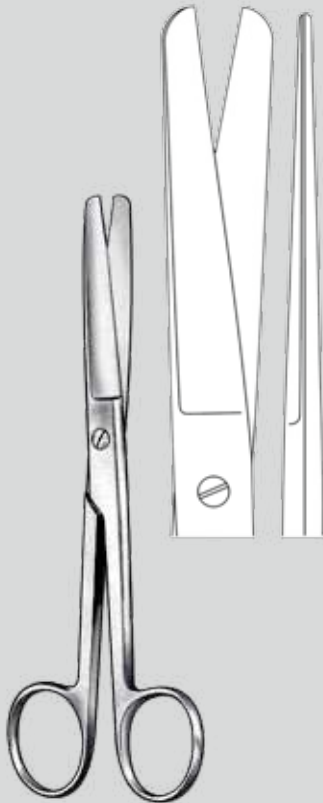

- INS-11-0201-10** 10.5 cm / 4¼"
 - INS-11-0201-11** 11.5 cm / 4½"
 - INS-11-0201-13** 13.0 cm / 5"
 - INS-11-0201-14** 14.5 cm / 5½"
 - INS-11-0201-15** 15.5 cm / 6"
 - INS-11-0201-16** 16.5 cm / 6½"
 - INS-11-0201-18** 18.5 cm / 7¼"
 - INS-11-0201-20** 20.0 cm / 8"
- Straight

Standard

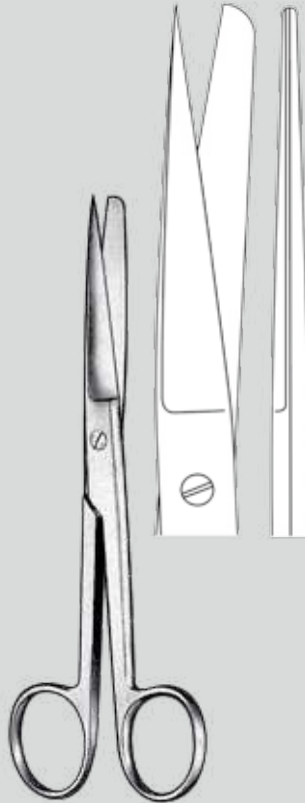

- INS-11-0203-10** 10.5 cm / 4¼"
 - INS-11-0203-11** 11.5 cm / 4½"
 - INS-11-0203-13** 13.0 cm / 5"
 - INS-11-0203-14** 14.5 cm / 5½"
 - INS-11-0203-15** 15.5 cm / 6"
 - INS-11-0203-16** 16.5 cm / 6½"
 - INS-11-0203-18** 18.5 cm / 7¼"
 - INS-11-0203-20** 20.0 cm / 8"
- Straight

Standard

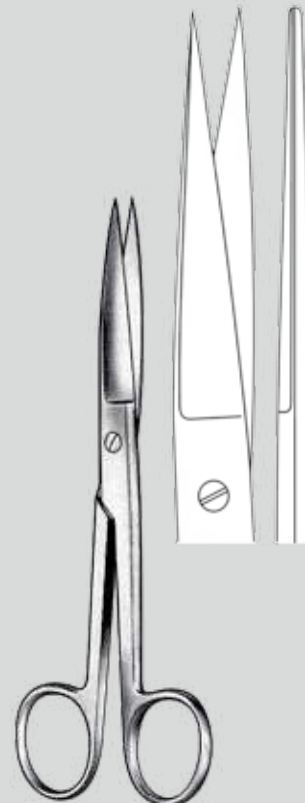

- INS-11-0205-10**
 - INS-11-0205-11**
 - INS-11-0205-13**
 - INS-11-0205-14**
 - INS-11-0205-15**
 - INS-11-0205-16**
 - INS-11-0205-18**
 - INS-11-0205-20**
- Straight

Standard

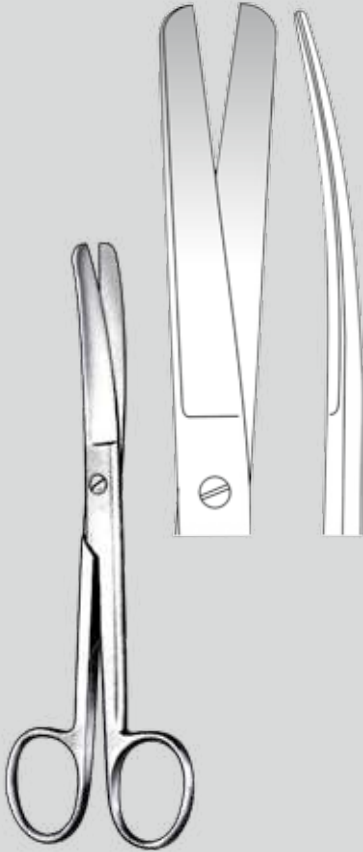

INS-11-0206-11	11.5 cm / 4½"
INS-11-0206-13	13.0 cm / 5"
INS-11-0206-14	14.5 cm / 5½"
INS-11-0206-15	15.5 cm / 6"
INS-11-0206-16	16.5 cm / 6½"
INS-11-0206-18	18.5 cm / 7¼"
INS-11-0206-20	20.0 cm / 8"

Curved

Standard

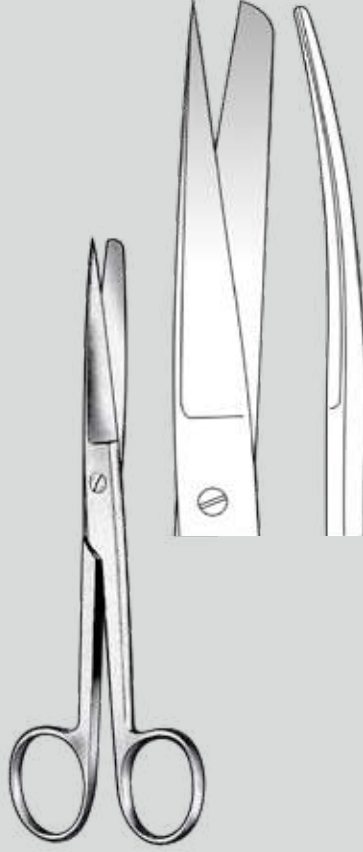

INS-11-0208-11	11.5 cm / 4½"
INS-11-0208-13	13.0 cm / 5"
INS-11-0208-14	14.5 cm / 5½"
INS-11-0208-15	15.5 cm / 6"
INS-11-0208-16	16.5 cm / 6½"
INS-11-0208-18	18.5 cm / 7¼"
INS-11-0208-20	20.0 cm / 8"

Curved

Standard

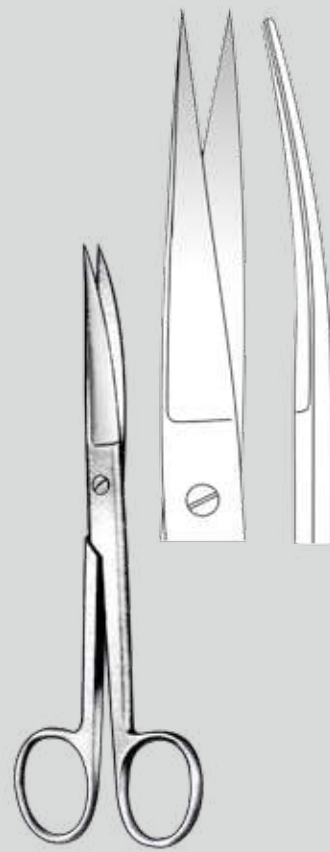



INS-11-0210-11	11.5 cm / 4½"
INS-11-0210-13	13.0 cm / 5"
INS-11-0210-14	14.5 cm / 5½"
INS-11-0210-15	15.5 cm / 6"
INS-11-0210-16	16.5 cm / 6½"
INS-11-0210-18	18.5 cm / 7¼"
INS-11-0210-20	20.0 cm / 8"

Curved



Mayo



		
INS-11-0271-14	<u>14 cm / 5³/₄"</u>	INS-11-0272-14
INS-11-0271-15	<u>15 cm / 6"</u>	INS-11-0272-15
INS-11-0271-17	<u>17 cm / 6³/₄"</u>	INS-11-0272-17
INS-11-0271-23	<u>23 cm / 9"</u>	INS-11-0272-23
	Straight	Curved



Mayo Harrington

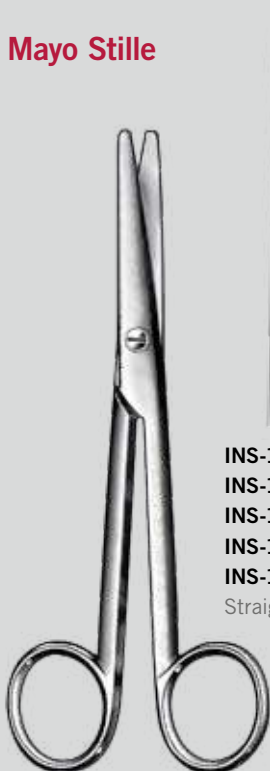

		
INS-11-3050-22	<u>22.5 cm / 9"</u>	INS-11-3055-22
INS-11-3050-30	<u>30 cm / 12"</u>	INS-11-3055-30
	Straight	Curved

Mayo Stille



		
INS-11-3060-15	<u>15 cm / 6"</u>	INS-11-3065-15
INS-11-3060-16	<u>16 cm / 6¹/₄"</u>	INS-11-3065-16
INS-11-3060-17	<u>17 cm / 6³/₄"</u>	INS-11-3065-17
INS-11-3060-19	<u>19 cm / 7¹/₂"</u>	INS-11-3065-19
INS-11-3060-21	<u>21 cm / 8¹/₂"</u>	INS-11-3065-21
	Straight	Curved

Mayo-Noble

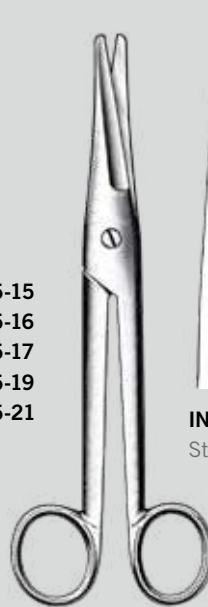

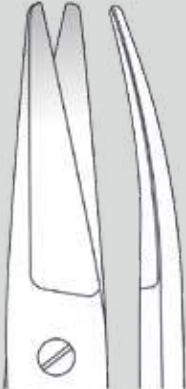
		
INS-11-3070-17	<u>17 cm / 6³/₄"</u>	INS-11-3071-17
	Straight	Curved

Metzenbaum



Metzenbaum



Metzenbaum



Metzenbaum

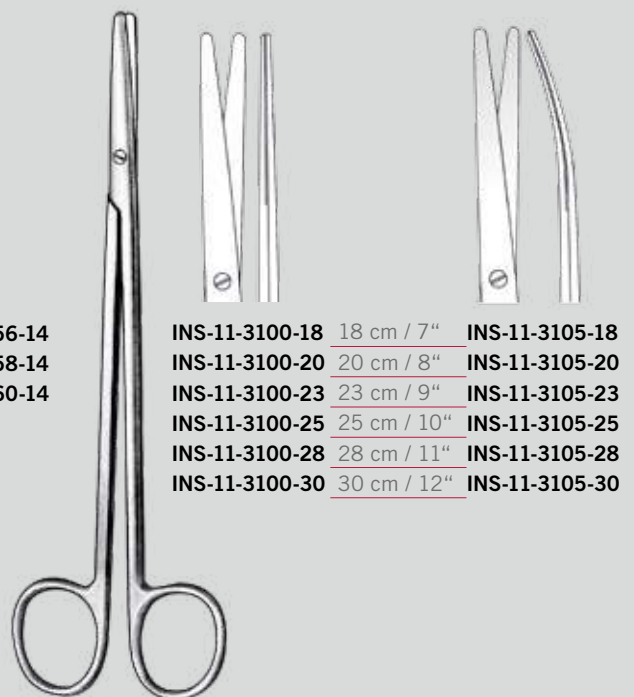

Metzenbaum-Nelson



INS-11-3110-18	18 cm / 7"	INS-11-3115-18	18 cm / 7"	INS-11-3120-18
INS-11-3110-20	20 cm / 8"	INS-11-3115-20	20 cm / 8"	INS-11-3120-20
INS-11-3110-23	23 cm / 9"	INS-11-3115-23	23 cm / 9"	INS-11-3120-23
INS-11-3110-25	25 cm / 10"	INS-11-3115-25	25 cm / 10"	INS-11-3120-25
INS-11-3110-28	28 cm / 11"	INS-11-3115-28	28 cm / 11"	INS-11-3120-28
INS-11-3110-30	30 cm / 12"	INS-11-3115-30	30 cm / 12"	INS-11-3120-30

Metzenbaum-Nelson

Lexer



INS-11-3125-18	18 cm / 7"
INS-11-3125-20	20 cm / 8"
INS-11-3125-23	23 cm / 9"
INS-11-3125-25	25 cm / 10"
INS-11-3125-28	28 cm / 11"
INS-11-3125-30	30 cm / 12"

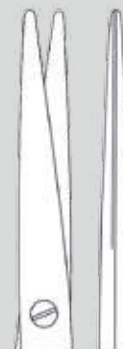





INS-11-3130-16	16 cm / 6¼"	INS-11-3135-16
INS-11-3130-21	21 cm / 8½"	INS-11-3135-21
Straight		Curved

SCISSORS



Metzenbaum-Fino

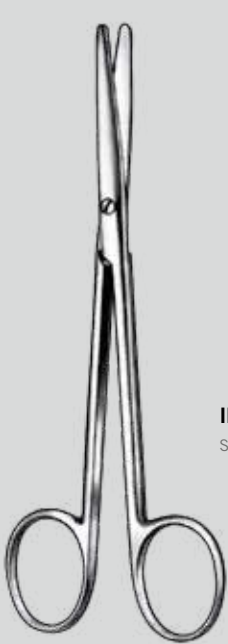

			
INS-11-0427-14 14.5 cm / 5½"	INS-11-0428-14 14.5 cm / 5½"	INS-11-0429-14 14.5 cm / 5½"	INS-11-0430-14
INS-11-0427-18 18 cm / 7"	INS-11-0428-18 18 cm / 7"	INS-11-0429-18 18 cm / 7"	INS-11-0430-18
INS-11-0427-20 20 cm / 8"	INS-11-0428-20 20 cm / 8"	INS-11-0429-20 20 cm / 8"	INS-11-0430-20
INS-11-0427-23 23 cm / 9"	INS-11-0428-23 23 cm / 9"	INS-11-0429-23 23 cm / 9"	INS-11-0430-23
Slender pattern	Slender pattern	Slender pattern	Slender pattern

Lexer-Fino



	
INS-11-3140-16 16 cm / 6¼"	INS-11-3145-16
Slender pattern	Slender pattern

Lexer-Baby

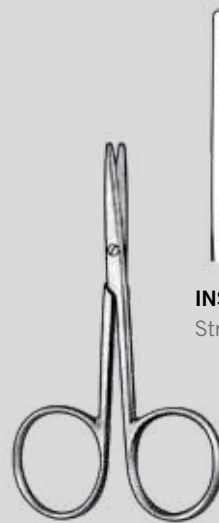

	
INS-11-3150-10 10 cm / 4"	INS-11-3151-10
Straight	Curved

Iris-Fine



INS-11-3345-11 11 cm / 4½" **INS-11-3346-11**
Straight Curved



INS-11-3350-09 9 cm / 3½" **INS-11-3355-09**
INS-11-3350-10 10.5 cm / 4¼" **INS-11-3355-10**
Straight Flat Curved Flat
INS-11-3351-09 9 cm / 3½" **INS-11-3356-09**
INS-11-3351-10 10.5 cm / 4¼" **INS-11-3356-10**
Straight Round Curved Round



Iris



INS-11-0731-11 11.5 cm / 4½" **INS-11-0732-11**
Flat Flat



INS-11-2030-11 11.5 cm / 4½" **INS-11-2035-11**
Round Round



INS-11-0734-11 11.5 cm / 4½" **INS-11-0736-11**

INS-11-2036-11 9 cm / 3½" **INS-11-2037-11**
Round Round

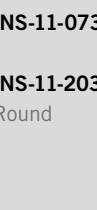
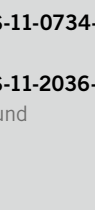

Stevens

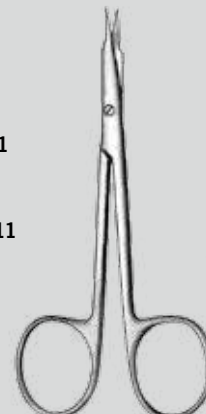

INS-11-3360-11 11 cm / 4½" **INS-11-3365-11**
INS-11-3361-10 10 cm / 3¾" **INS-11-3366-10**



INS-11-3362-10 10 cm / 3¾" **INS-11-3367-10**
With large rings With large rings



INS-11-3370-11 11 cm / 4½" **INS-11-3375-11**
INS-11-3371-10 10 cm / 3¾" **INS-11-3376-10**

INS-11-3372-10 10 cm / 3¾" **INS-11-3377-10**
With large rings With large rings

SCISSORS

Strabismus



INS-11-3380-11 11.5 cm / 4½"
Straight



INS-11-3381-11
Curved

Kilner



INS-11-0695-11 11.5 cm / 4½"
Straight



INS-11-0696-11
Curved

Spencer



INS-11-0925-09 Normal · 9 cm / 3½"

INS-11-3390-09 Angled · 9 cm / 3½"

INS-11-3391-09 Delicate · 9 cm / 3½"

INS-11-3392-09 Delicate, Angled · 9 cm / 3½"

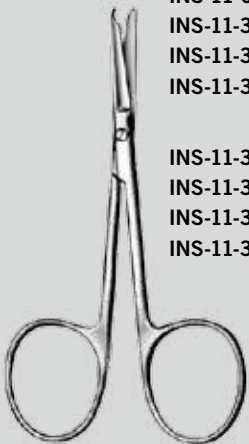

INS-11-3395-11 Normal · 11 cm / 4¼"

INS-11-3396-11 Angled · 11 cm / 4¼"

INS-11-3397-11 Delicate · 11 cm / 4¼"

INS-11-3398-11 Delicate, Angled · 11 cm / 4¼"

Spencer



INS-11-0927-13 13 cm / 5"
Straight

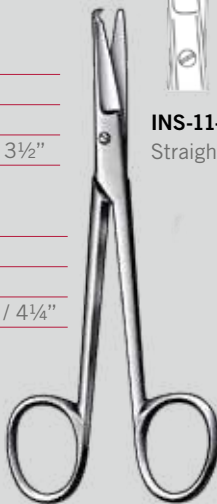

Littauer



INS-11-0935-14 14 cm / 5½"



11-3400-13
Side bend

Crown-Beebee

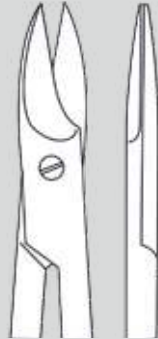

INS-11-0971-10 10 cm / 4"
Straight

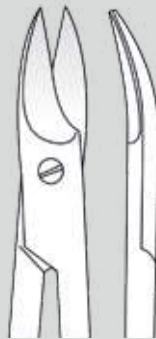

INS-11-0972-10
Curved

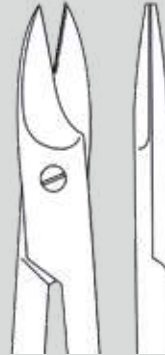

INS-11-0975-10 12 cm / 4¾"
1 Blade
saw edge
Straight

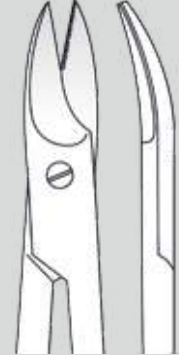

INS-11-0976-10
1 Blade
saw edge
Curved

Universal



INS-11-0966-12 12 cm / 4¾"
Serrated

Locklin



INS-11-0708-16 16 cm / 6¼"

Locklin



INS-11-0706-16 16 cm / 6¼"

Westcott



INS-11-3505-11

11.5 cm / 4½"



INS-11-3506-11



INS-11-3510-09

9 cm / 3½"



INS-11-3515-11

11 cm / 4½"

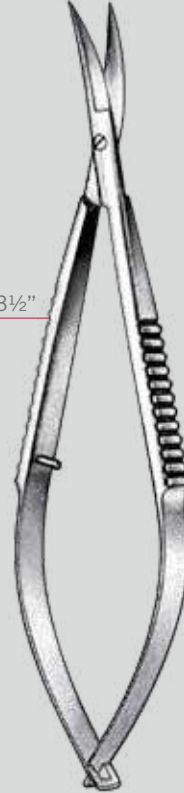

INS-11-3520-12

12 cm / 5"



INS-11-3525-09

9 cm / 3½"



- INS-21-2001-14** Black · 14.5 cm / 5¾"
- INS-21-2002-14** Red · 14.5 cm / 5¾"
- INS-21-2003-14** Blue · 14.5 cm / 5¾"
- INS-21-2004-14** Yellow · 14.5 cm / 5¾"
- INS-21-2005-14** Orange · 14.5 cm / 5¾"
- INS-21-2006-14** Bright pink · 14.5 cm / 5¾"



- INS-21-0310-18** Black · 18 cm / 7"
- INS-21-2010-18** Red · 18 cm / 7"
- INS-21-2011-18** Blue · 18 cm / 7"
- INS-21-2012-18** Yellow · 18 cm / 7"
- INS-21-2013-18** Orange · 18 cm / 7"
- INS-21-2014-18** Bright pink · 18 cm / 7"

Knowles



- INS-21-0261-14** 14 cm / 5½" **INS-21-2020-14**
- Straight Angled

Lister/Lister TC



- | | |
|-----------------------------------|------------------------|
| INS-21-0266-09 9 cm / 3½" | INS-11-3570-09T |
| INS-21-0266-11 11 cm / 4½" | INS-11-3570-11T |
| INS-21-0266-14 14 cm / 5½" | INS-11-3570-14T |
| INS-21-0266-16 16 cm / 6¼" | INS-11-3570-16T |
| INS-21-0266-18 18 cm / 7" | INS-11-3570-18T |
| INS-21-0266-20 20 cm / 8" | INS-11-3570-20T |
| without TC | with TC |

SCISSORS. with Tungsten Carbide Inserts

Standard, TC



INS-11-3580-14T	14.5 cm / 5¾"	INS-11-3585-14T
INS-11-3580-16T	16 cm / 6¼"	INS-11-3585-16T
INS-11-3580-18T	18 cm / 7"	INS-11-3585-18T
Straight		Curved

Standard, TC

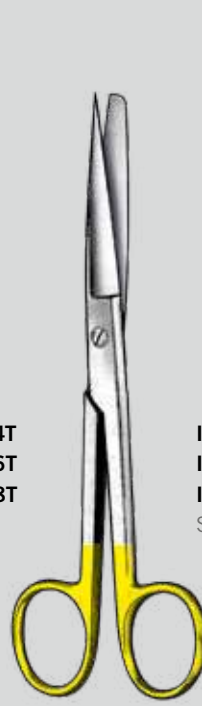

INS-11-3590-14T	14.5 cm / 5¾"	INS-11-3595-14T
INS-11-3590-16T	16 cm / 6¼"	INS-11-3595-16T
INS-11-3590-18T	18 cm / 7"	INS-11-3595-18T
Straight		Curved

Standard, TC

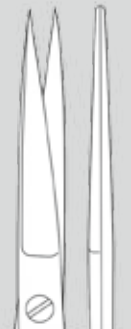
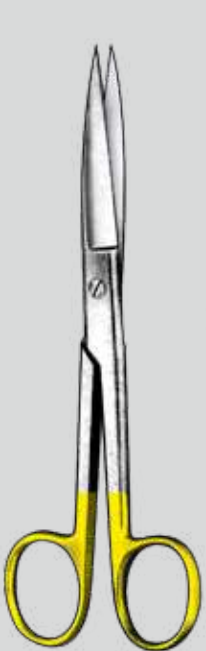

INS-11-3600-14T	14.5 cm / 5¾"	INS-11-3605-14T
INS-11-3600-16T	16 cm / 6¼"	INS-11-3605-16T
INS-11-3600-18T	18 cm / 7"	INS-11-3605-18T
Straight		Curved

Mayo, TC



INS-11-3610-14T	14.5 cm / 5¾"	INS-11-3615-14T
INS-11-3610-17T	17 cm / 6¾"	INS-11-3615-17T
INS-11-3610-23T	23 cm / 9"	INS-11-3615-23T
Straight		Curved

SCISSORS. with Tungsten Carbide Inserts

Mayo-Stille, TC



Lexer, TC



Mayo-Lexer, TC



Metzenbaum, TC



Metzenbaum , TC



INS-11-3655-14T	14.5 cm / 5¾"	INS-11-3660-14T
INS-11-3655-18T	18 cm / 7"	INS-11-3660-18T
INS-11-3655-20T	20 cm / 8"	INS-11-3660-20T
INS-11-3655-23T	23 cm / 9"	INS-11-3660-23T
INS-11-3655-25T	25 cm / 10"	INS-11-3660-25T
INS-11-3655-28T	28 cm / 11"	INS-11-3660-28T
INS-11-3655-30T	30 cm / 12"	INS-11-3660-30T
Straight		Curved

Metzenbaum- Fino , TC

Delicate
Standard

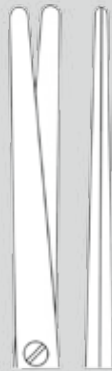

INS-11-1055-14T	14.5 cm / 5¾"	INS-11-1056-14T
INS-11-1055-18T	18 cm / 7"	INS-11-1056-18T
INS-11-1055-20T	20 cm / 8"	INS-11-1056-20T
INS-11-1055-23T	23 cm / 9"	INS-11-1056-23T
INS-11-1055-25T	25 cm / 10"	INS-11-1056-25T
INS-11-1055-28T	28 cm / 11"	INS-11-1056-28T
INS-11-1055-30T	30 cm / 12"	INS-11-1056-30T
Straight		Curved

Metzenbaum-Lahey, TC

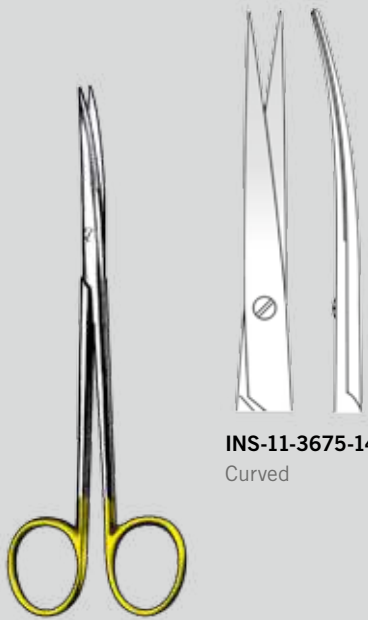

INS-11-3675-14T 14.5 cm / 5¾"
Curved

Iris, TC

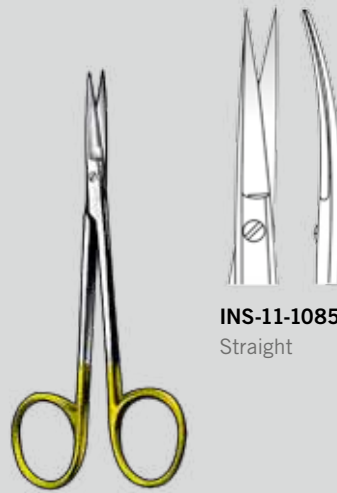

INS-11-1085-11T 11.5 cm / 4½" **INS-11-1086-11T**
Straight Curved

Iris, TC



INS-11-1090-11T 11.5 cm / 4½"
angled to side
INS-11-1090-13T 13 cm / 5"
angled to side

Goldman- Fox, TC

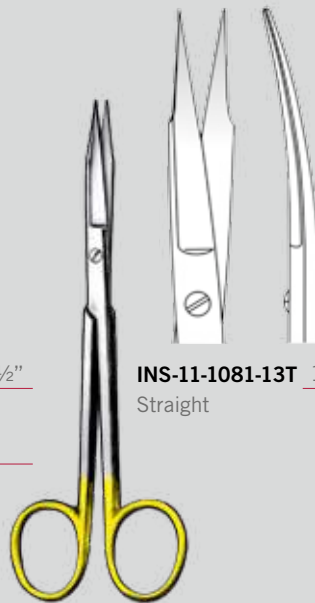

INS-11-1081-13T 13 cm / 5" **INS-11-1082-13T**
Straight Curved

Ragnell (Kilner), TC



INS-11-1095-12T 12 cm / 4¾"

NEEDLE HOLDERS

Derf



INS-20-0427-12 12 cm / 4¾"

Derf



INS-20-0429-12 12.5 cm / 5"

Collier



INS-20-0433-12 12.5 cm / 5"

Halsey
Delicate



INS-20-0437-13 12.5 cm / 5"

INS-20-0437-11 11 cm / 4¼"

Smooth jaws

Webster
Delicate

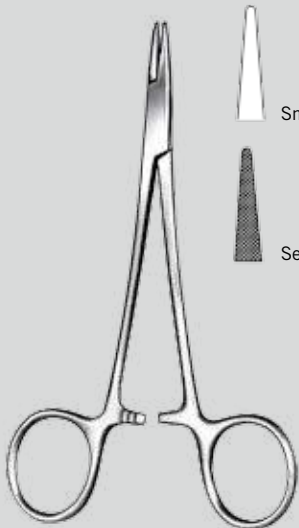

Smooth jaws



Serrated jaws

INS-20-0435-13 13 cm / 5"

Smooth

Neivert

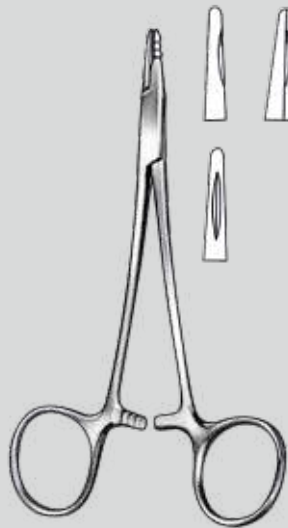

INS-20-3001-13 **INS-20-0439-13** 13 cm / 5"

Serrated

Kilner

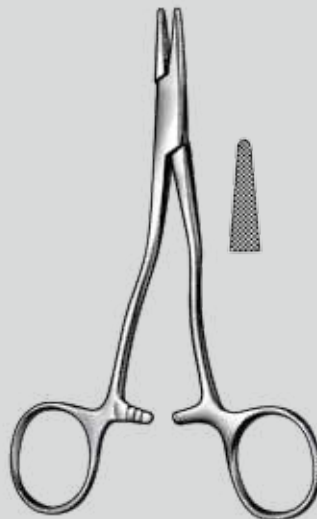

INS-20-0732-13 13,5 cm / 5¼"

Hegar-Baumgartner

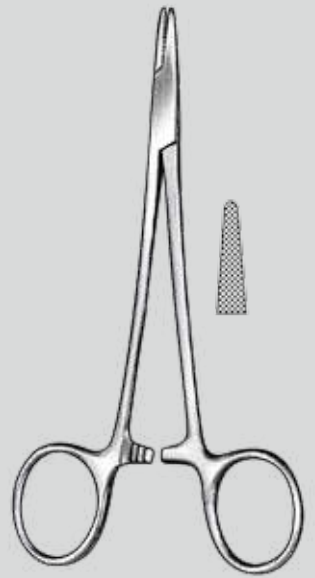

INS-20-0441-14 14 cm / 5½"

Crile-Murray

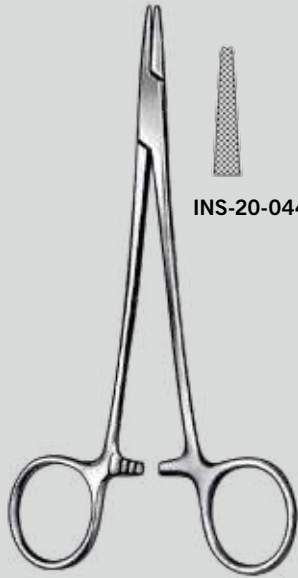

INS-20-0449-15 15 cm / 6"

Crile-Wood

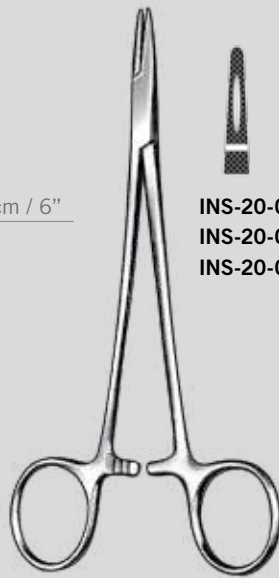

INS-20-0451-15 15 cm / 6"
INS-20-0451-18 18 cm / 7"
INS-20-0451-20 20 cm / 8"

**Mayo-Hegar
Delicate**

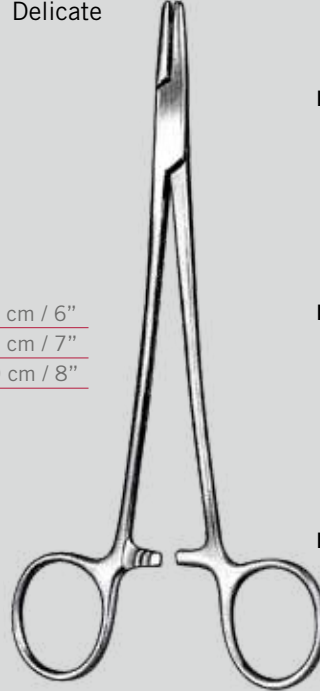

INS-20-0497-16 16 cm / 6¼"

INS-20-0497-18 18 cm / 7"

INS-20-0497-20 20 cm / 8"

Mayo-Hegar

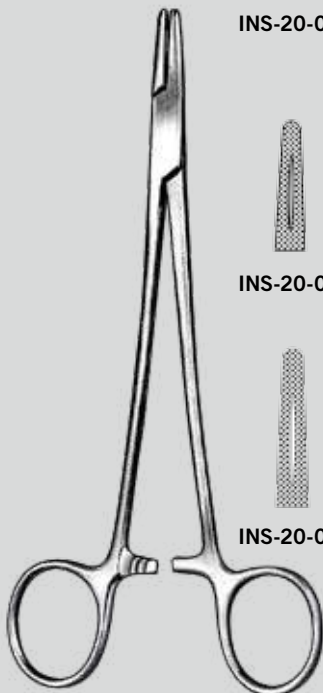

INS-20-0491-14 14 cm / 5½"

INS-20-0491-18 18 cm / 7"

INS-20-0491-24 24 cm / 9½"

Adson

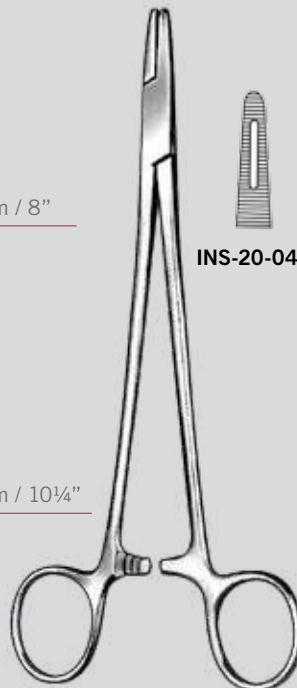

INS-20-0461-18 18 cm / 7"

Metzenbaum

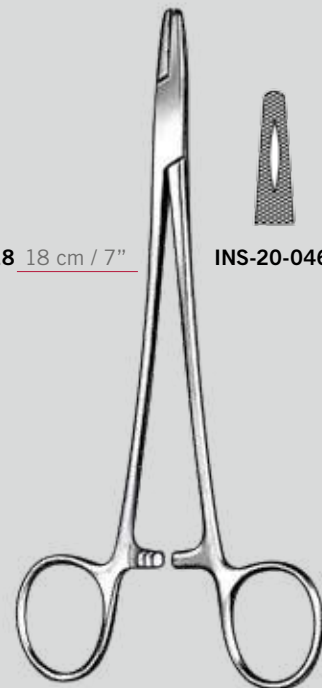

INS-20-0465-18 18 cm / 7"

NEEDLE HOLDERS

Mathieu



INS-20-0617-14 14 cm / 5½" INS-20-2035-14
 INS-20-0617-16 16 cm / 6¼" INS-20-2035-16
 INS-20-0617-17 17 cm / 6¾" INS-20-2035-17
 INS-20-0617-20 20 cm / 8" INS-20-2035-20
 INS-20-0617-24 24 cm / 9½" INS-20-2035-24

Mathieu



INS-20-0627-14 14 cm / 5½"
 Slender jaws

Olsen-Hegar



INS-20-0565-12 12 cm / 4¾", Mini
 INS-20-0565-14 14 cm / 5½"
 INS-20-0565-16 16 cm / 6¼"
 INS-20-0565-18 18 cm / 7"

Gillies

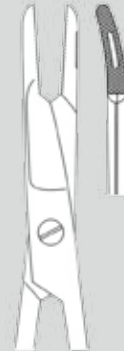

INS-20-0570-16 16 cm / 6¼"
 Serrated jaws

McPherson



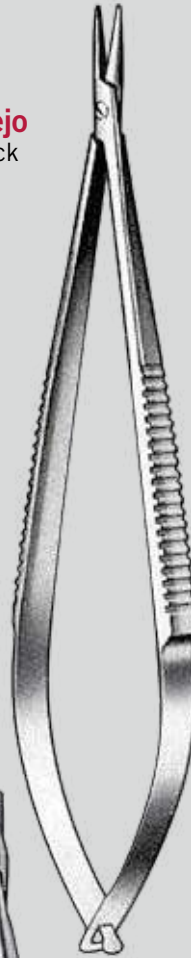

 **INS-13-2044-10** 10 cm / 4"

Castroviejo
Without lock



 **INS-20-0413-14** 13.5 cm / 5½"



 **INS-20-0414-14** 13.5 cm / 5½"

 **INS-20-2045-14** 13.5 cm / 5½"

 **INS-20-2046-14** 13.5 cm / 5½"

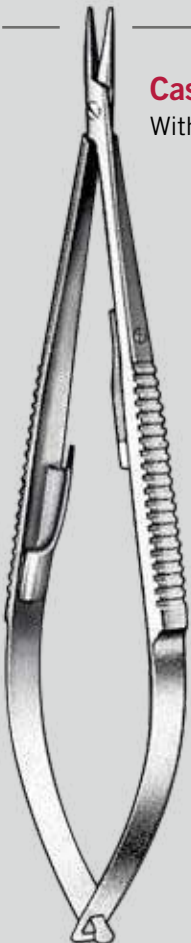

Castroviejo
With lock



	INS-20-2050-13 <u>13 cm / 5¼"</u>		INS-20-2055-13
	INS-20-2050-16 <u>16 cm / 6¼"</u>		INS-20-2055-16
	INS-20-2050-18 <u>18 cm / 7"</u>		INS-20-2055-18
	INS-20-2050-20 <u>20 cm / 8"</u>		INS-20-2055-20
	INS-20-2050-23 <u>23 cm / 9"</u>		INS-20-2055-23

Castroviejo
Extra delicate,
with lock



	INS-20-0407-14 <u>13.5 cm / 5½"</u>		INS-20-0408-14
---	--	---	-----------------------

	INS-20-2051-13 <u>13 cm / 5¼"</u>		INS-20-2056-13
	INS-20-2051-16 <u>16 cm / 6¼"</u>		INS-20-2056-16
	INS-20-2051-18 <u>18 cm / 7"</u>		INS-20-2056-18
	INS-20-2051-20 <u>20 cm / 8"</u>		INS-20-2056-20
	INS-20-2051-23 <u>23 cm / 9"</u>		INS-20-2056-23

NEEDLE HOLDERS. with Tungsten Carbide Inserts

Derf, TC

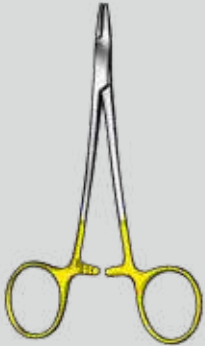

0.4
INS-20-0733-12T 12 cm / 4¾"
Mini profile

Webster, TC

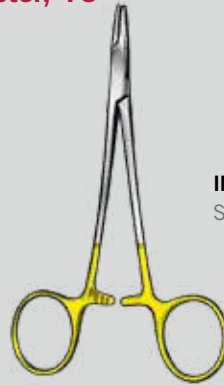

INS-20-0738-12T 12 cm / 4¾"
Smooth



INS-20-2070-12T
Serrated

Kilner, TC



0.5
INS-20-0732-13T 13,5 cm / 5¼"
Normal profile

Webster, TC
Delicate



INS-20-2073-13T 12 cm / 4¾"
Smooth



INS-20-2075-13T
Serrated

Halsey, TC



INS-20-0737-13T 13 cm / 5"
Smooth



0.4
INS-20-0738-13T
Serrated
Mini profile

Hegar-Baumgartner, TC

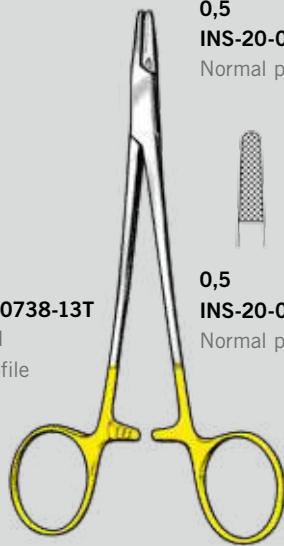

0.5
INS-20-0735-13T 13 cm / 5"
Normal profile



0.5
INS-20-0735-14T 14 cm / 5½"
Normal profile

Crile-Wood, TC

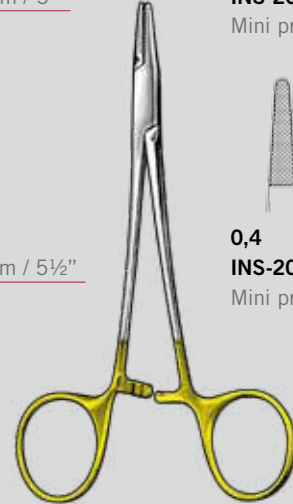

0.4
INS-20-0705-13T
Mini profile



0.4
INS-20-0705-15T
Mini profile

With automatic release ratchet

Crile-Wood, TC



0,4
INS-20-0739-15T 15 cm / 6"
INS-20-0739-18T 18 cm / 7"
INS-20-0739-20T 20 cm / 8"
INS-20-0739-23T 23 cm / 9"
INS-20-0739-25T 25 cm / 10"
INS-20-0739-30T 30 cm / 12"
 Mini profile

Mayo-Hegar, TC

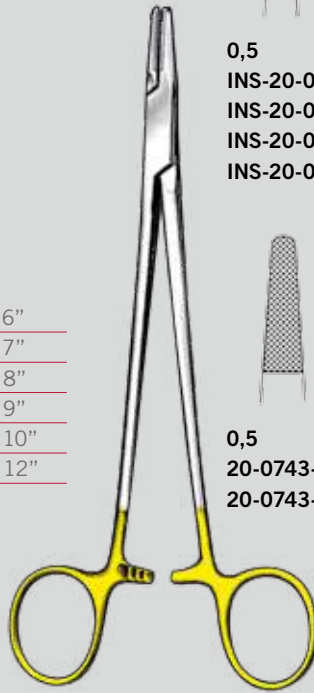

0,5
INS-20-0743-14T 14 cm / 5¼"
INS-20-0743-16T 16 cm / 6¼"
INS-20-0743-18T 18 cm / 7"
INS-20-0743-20T 20 cm / 8"

0,5
20-0743-35T 35 cm / 14"
20-0743-45T 45 cm / 18"



0,5
INS-20-0743-24T 24 cm / 9½"
INS-20-0743-26T 26 cm / 10¼"
INS-20-0743-30T 30 cm / 12"



0,5
INS-20-0743-40T 40 cm / 16"
 Normal profile

Olsen-Hegar, TC



0,2
INS-20-3155-12T 12 cm / 4¾"
 Micro profile

0,4
INS-20-0773-14T 14 cm / 5½"
INS-20-0773-16T 16 cm / 6¼"
INS-20-0773-17T 17 cm / 6½"
INS-20-0773-19T 19 cm / 7½"
 Mini profile

De Bakey, TC

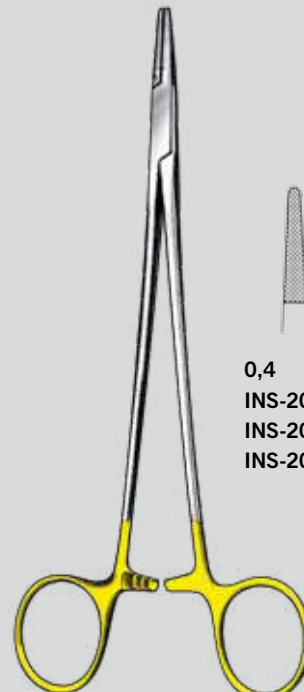

0,4
INS-20-0747-18T 18 cm / 7"
INS-20-0747-20T 20 cm / 8"
INS-20-0747-23T 23 cm / 9"



McPherson, TC



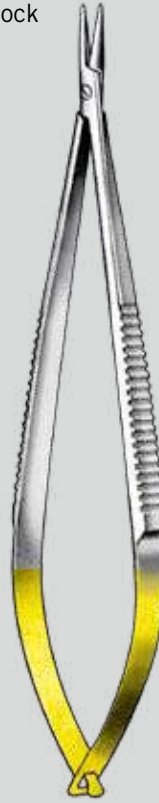

INS-20-3170-10T 10 cm / 4"

Castroviejo, TC
Without lock





INS-20-3175-13T 13.5 cm / 5½"  INS-20-3176-13T

INS-20-3177-13T 13.5 cm / 5½"  INS-20-3178-13T



Castroviejo, TC
With lock





INS-20-0721-13T 13 cm / 5¼"  INS-20-0722-13T
INS-20-0721-14T 14 cm / 5½" INS-20-0722-14T
INS-20-0721-16T 16 cm / 6¼" INS-20-0722-16T
INS-20-0721-18T 18 cm / 7" INS-20-0722-18T
INS-20-0721-20T 20 cm / 8" INS-20-0722-20T
INS-20-0721-21T 21 cm / 8½" INS-20-0722-21T
INS-20-0721-23T 23 cm / 9" INS-20-0722-23T
Smooth, straight Smooth, curved

Castroviejo, TC
Extra delicate,
with lock



INS-20-3180-13T 13.5 cm / 5½"  20-3181-13T

INS-20-2100-13T 13 cm / 5¼"  INS-20-2105-13T
INS-20-2100-14T 14 cm / 5½" INS-20-2105-14T
INS-20-2100-16T 16 cm / 6¼" INS-20-2105-16T
INS-20-2100-18T 18 cm / 7" INS-20-2105-18T
INS-20-2100-20T 20 cm / 8" INS-20-2105-20T
INS-20-2100-21T 21 cm / 8½" INS-20-2105-21T
INS-20-2100-23T 23 cm / 9" INS-20-2105-23T
Micro profile Micro profile

Farabeuf

Set of 2

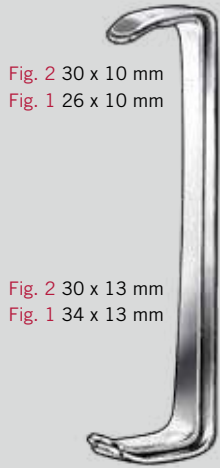

Fig. 2 30 x 10 mm
Fig. 1 26 x 10 mm

Fig. 2 30 x 13 mm
Fig. 1 34 x 13 mm

INS-15-0764-00 12 cm / 4¾"

Farabeuf

Set of 2



Fig. 2 27 x 16 mm
Fig. 1 23 x 16 mm

Fig. 2 26 x 16 mm
Fig. 1 30 x 16 mm

INS-15-0766-00 15 cm / 6"

Collin

Set of 2

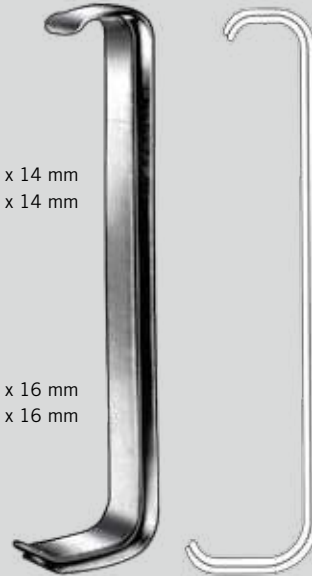

Fig. 2 21 x 14 mm
Fig. 1 17 x 14 mm

Fig. 2 28 x 16 mm
Fig. 1 32 x 16 mm

INS-15-3001-15 15 cm / 6"

Crile

11 x 4 mm

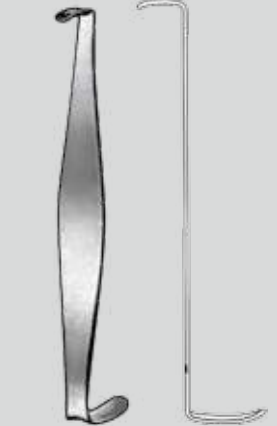

19 x 6 mm

INS-15-3005-11 11 cm / 4¼"

Mini-Roux



INS-15-0768-06 14 cm / 5½"

Baby-Roux

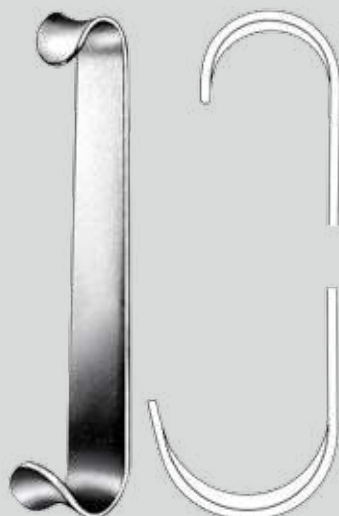

INS-15-0770-13 13 cm / 5¼"

Roux



INS-15-0756-00 Set
INS-15-0756-01 14 cm / 5½"
INS-15-0756-02 15 cm / 6"
INS-15-0756-03 17 cm / 6¾"
INS-15-0756-04 18 cm / 7"

Parker

Set of 2

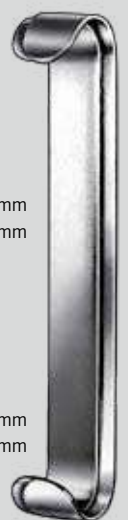
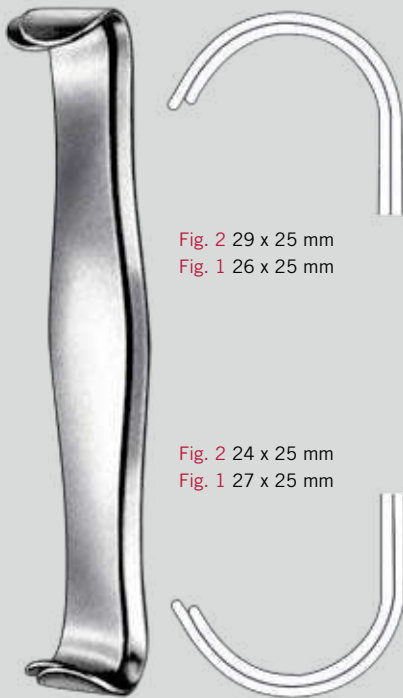

Fig. 2 22 x 15 mm
Fig. 1 19 x 15 mm

Fig. 2 19 x 15 mm
Fig. 1 22 x 15 mm

INS-15-0774-01

Parker
Set of 2



INS-15-0774-02 18 cm / 7"

Parker-Motts
Set of 2

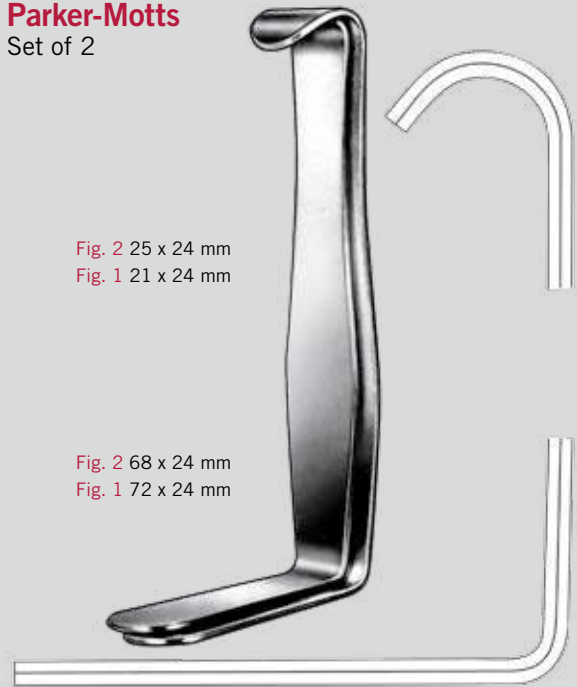

INS-15-3010-16 16 cm / 6¼"

Mathieu



INS-15-3020-20 20 cm / 8"

Parker-Langenbeck
Set of 2



INS-15-3015-21 21 cm / 8¼"

Skin Hook

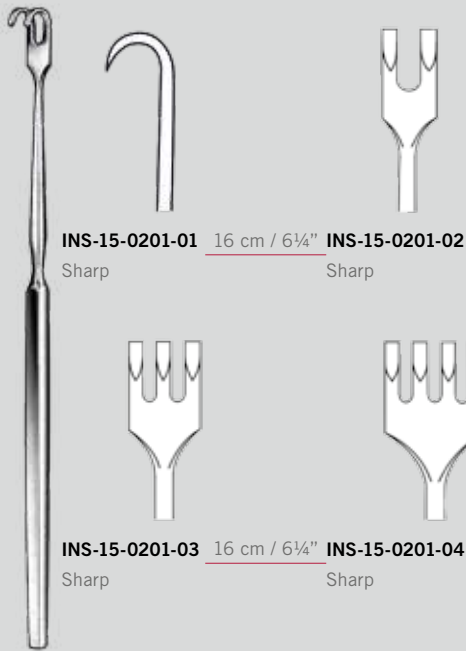

Skin Hook

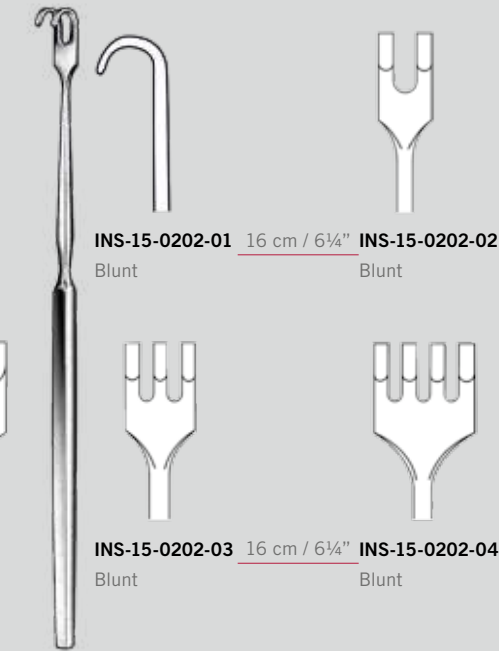

Skin Hook



Skin Hook



**Knapp
Flexible**



Joseph



INS-15-3130-16 16 cm / 6¼"
Fig. 1
Sharp



INS-15-3131-16 16 cm / 6¼"
Fig. 2
Sharp



INS-15-3132-16 16 cm / 6¼"
Fig. 3
Sharp



INS-15-3133-16 16 cm / 6¼"
Fig. 4
Sharp



Graefe

O'Connor

Guthrie



INS-15-3135-16 16 cm / 6¼"
Sharp



INS-15-3136-16
Blunt



INS-15-3140-16 16 cm / 6¼"

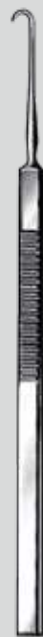

INS-15-3145-16
1.5 mm



INS-15-3146-16
2 mm



Desmarres



INS-15-3150-16 16 cm / 6¼"
8 mm

INS-15-3151-16 16 cm / 6¼"
10 mm

INS-15-3152-16 16 cm / 6¼"
12 mm

INS-15-3153-16 16 cm / 6¼"
14 mm

INS-15-3154-16 16 cm / 6¼"
16 mm

INS-15-3155-16 16 cm / 6¼"
18 mm

Langenbeck-Green



INS-15-3165-16 16 cm / 6¼"
16 x 6 mm

INS-15-3166-16 16 cm / 6¼"
24 x 6 mm

Mini-Langenbeck

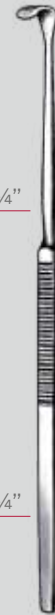

INS-15-3170-16 16 cm / 6¼"
10 x 6 mm

INS-15-3171-16 16 cm / 6¼"
17 x 5 mm

INS-15-3172-16 16 cm / 6¼"
20 x 6 mm

INS-15-3173-16 16 cm / 6¼"
22 x 8 mm

Cushing



INS-15-3175-20 20 cm / 8" 8 mm

INS-15-3180-20 10 mm

INS-15-3176-20 20 cm / 8" 12 mm

INS-15-3181-20 14 mm

INS-15-3177-20 20 cm / 8" 16 mm

INS-15-3182-20 18 mm

Cushing



INS-15-3185-24 24 cm / 9½" 8 mm

INS-15-3190-24 10 mm

INS-15-3186-24 24 cm / 9½" 12 mm

INS-15-3191-24 14 mm

INS-15-3187-24 24 cm / 9½" 16 mm

INS-15-3192-24 18 mm

RETRACTORS

Ragnell-Davis



8 x 4 mm

15 x 5.5 mm

INS-15-0265-14 14 cm / 5½"

Senn-Green



INS-15-0262-01 15 cm / 6"
10 x 6 mm

INS-15-0262-02 15 cm / 6"
20 x 6 mm

Senn-Miller

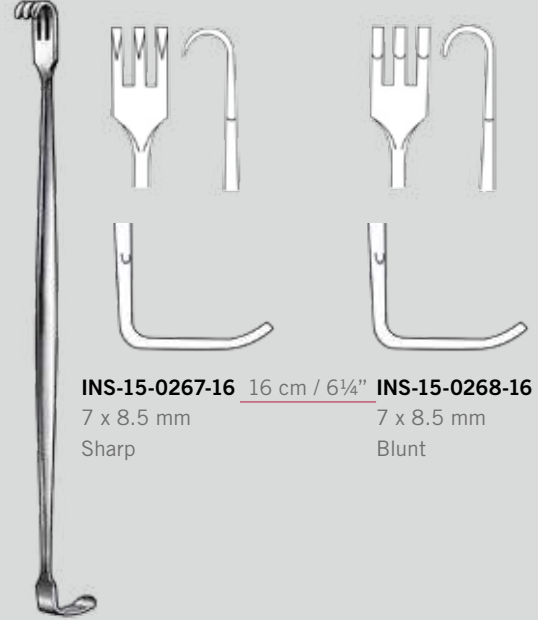

INS-15-0267-16 16 cm / 6¼" 7 x 8.5 mm
Sharp

INS-15-0268-16 7 x 8.5 mm
Blunt

Meyerding

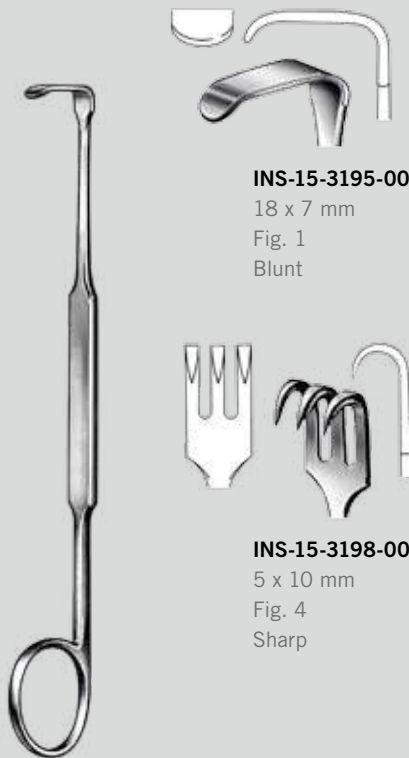

INS-15-3195-00 18 cm / 7"
18 x 7 mm
Fig. 1
Blunt



INS-15-3196-00 18 cm / 7"
16 x 5 mm
Fig. 2
Toothed



INS-15-3197-00 18 cm / 7"
7 x 4 mm
Fig. 3
Toothed



INS-15-3198-00 18 cm / 7"
5 x 10 mm
Fig. 4
Sharp



INS-15-3199-00 18 cm / 7"
11 x 4 mm
Fig. 5
Blunt



INS-15-3200-00 18 cm / 7"
6 x 4 mm
Fig. 6
Saddle shaped

Finsen



INS-15-3450-07 7 cm / 2¾" Sharp



INS-15-3455-07 Blunt



INS-15-3460-08 8 cm / 3¼"

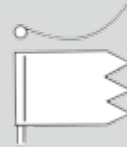

Buckley



INS-15-3465-06 6 cm / 2½"



Alm



INS-15-3470-07 7 cm 2¾ mm Sharp
INS-15-3470-10 10 cm 4 mm Sharp

INS-15-3471-07 Blunt
INS-15-3471-10 Blunt

Jansen



INS-15-3480-10 10 cm 4 mm Sharp



INS-15-3481-10 Blunt

Alm



INS-15-3475-10 10 cm 4 mm Sharp



Blunt

RETRACTORS

Weitlaner

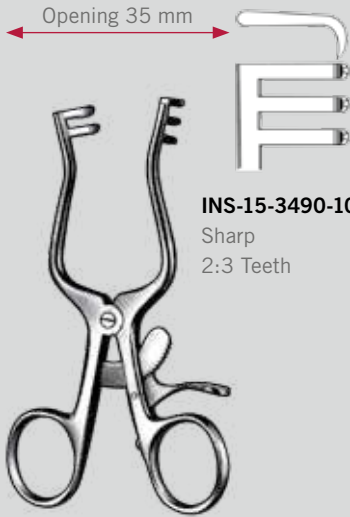

INS-15-3490-10 10.5 cm / 4¼"
Sharp
2:3 Teeth

INS-15-3491-10
Blunt
2:3 Teeth

Weitlaner

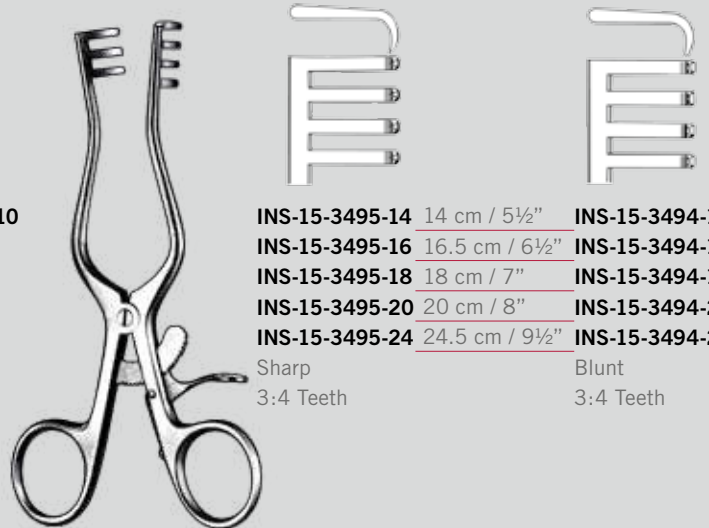

INS-15-3495-14 14 cm / 5½"
INS-15-3495-16 16.5 cm / 6½"
INS-15-3495-18 18 cm / 7"
INS-15-3495-20 20 cm / 8"
INS-15-3495-24 24.5 cm / 9½"
Sharp
3:4 Teeth

INS-15-3494-14
INS-15-3494-16
INS-15-3494-18
INS-15-3494-20
INS-15-3494-24
Blunt
3:4 Teeth

West

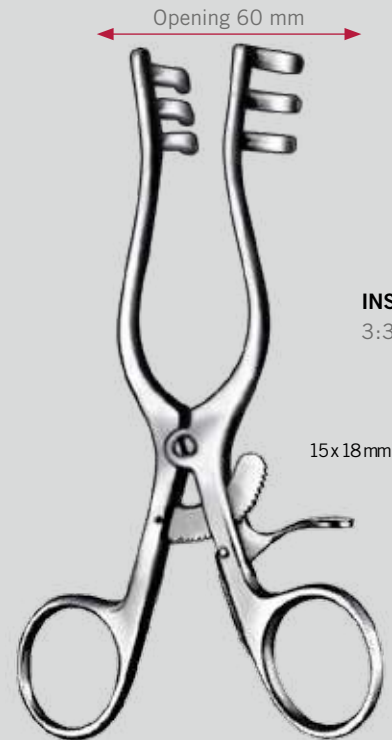

INS-15-3500-13 13 cm / 5¼"
3:3 Teeth

Weitlaner-Wullstein

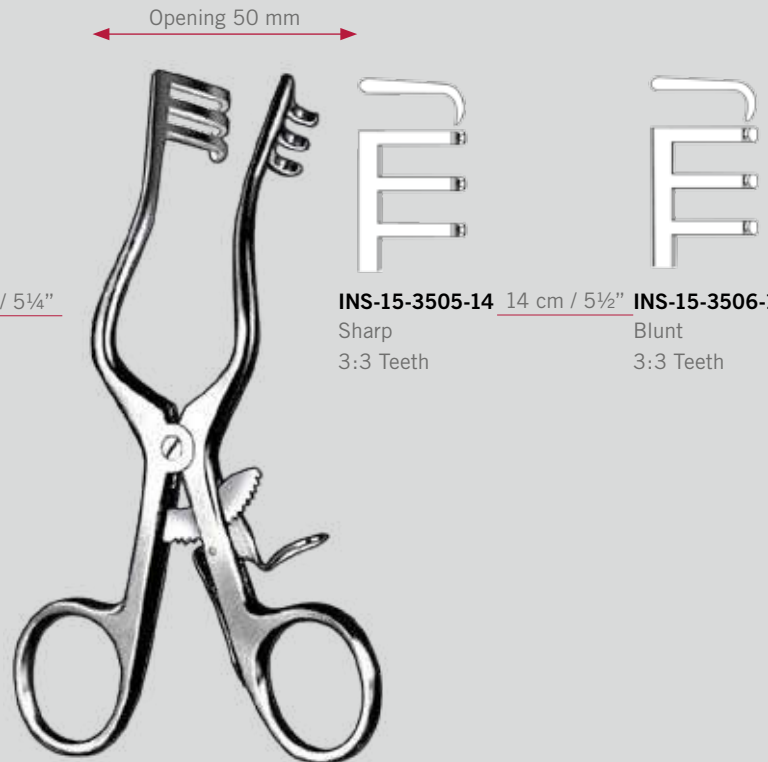

INS-15-3505-14 14 cm / 5½"
Sharp
3:3 Teeth

INS-15-3506-14
Blunt
3:3 Teeth

Weitlaner

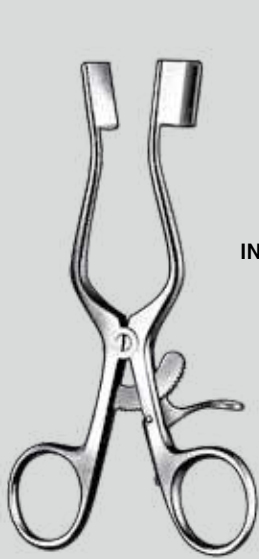

INS-15-3510-14 14 cm / 5½"

Mollison



INS-15-3515-15 15 cm / 6"
4:4 Teeth
Sharp

Milligan

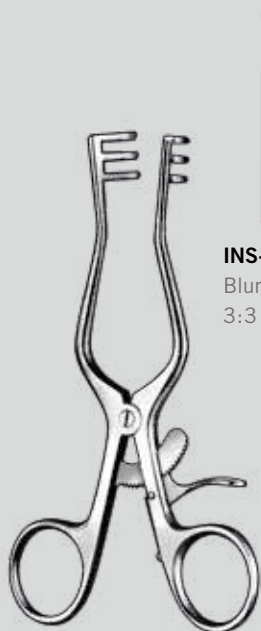

INS-15-3525-13 13 cm / 5"
Blunt
3:3 Teeth

Plester



INS-15-3530-11 11 cm / 4¼"
Blunt
2 Teeth

Plester

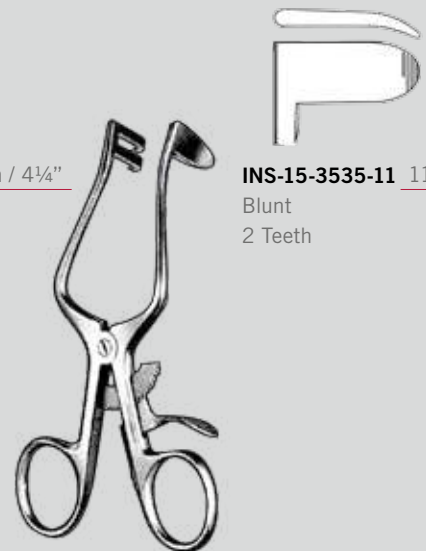

INS-15-3535-11 11 cm / 4¼"
Blunt
2 Teeth

Perkins

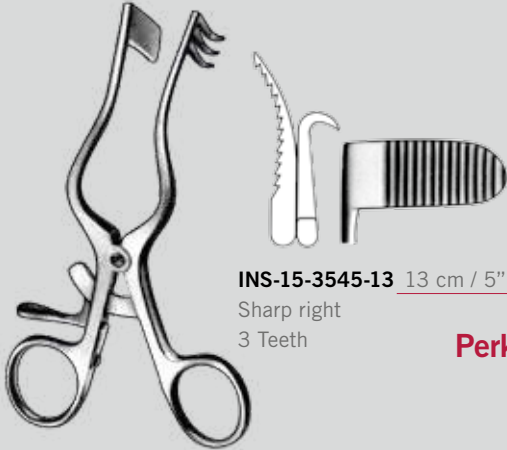

INS-15-3545-13 13 cm / 5"
Sharp right
3 Teeth

Perkins



INS-15-3550-13 13 cm / 5"
Sharp left
3 Teeth

Norfolk-Norwich



INS-15-3565-22 22 cm / 8¾"
Blunt
5:4 Teeth

Gelpi



INS-15-3660-09 9 cm / 3½"
INS-15-3660-11 11.5 cm / 4½"
INS-15-3660-14 14 cm / 5½"
INS-15-3660-16 16 cm / 6¼"
INS-15-3660-18 18 cm / 7"
INS-15-3660-20 20 cm / 8"

Gelpi

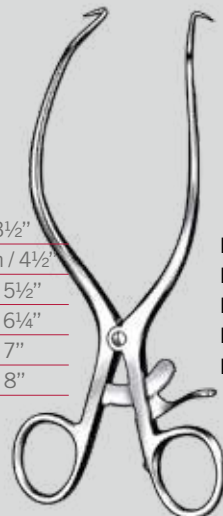

INS-15-3665-09 9 cm / 3½"
INS-15-3665-11 11.5 cm / 4½"
INS-15-3665-14 14 cm / 5½"
INS-15-3665-16 16 cm / 6¼"
INS-15-3665-18 18 cm / 7"

Gelpi

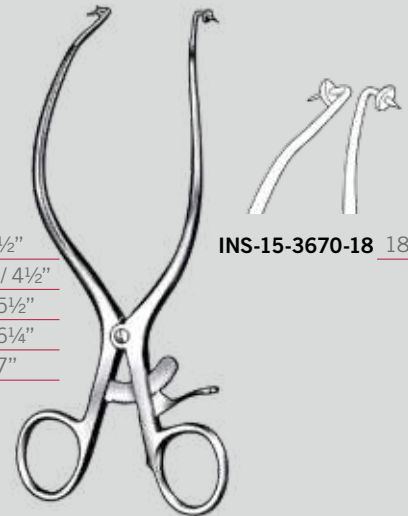

INS-15-3670-18 18 cm / 7"

Balfour-Baby

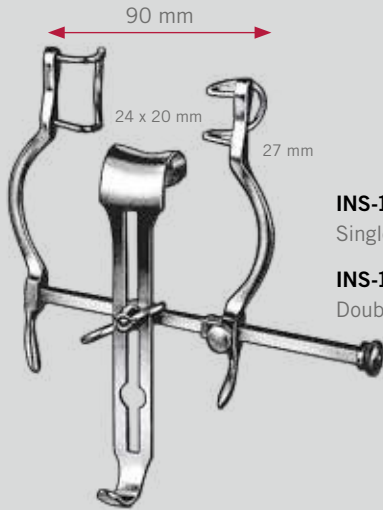

INS-15-3805-00

Single bar

INS-15-3806-00

Double bar

Balfour

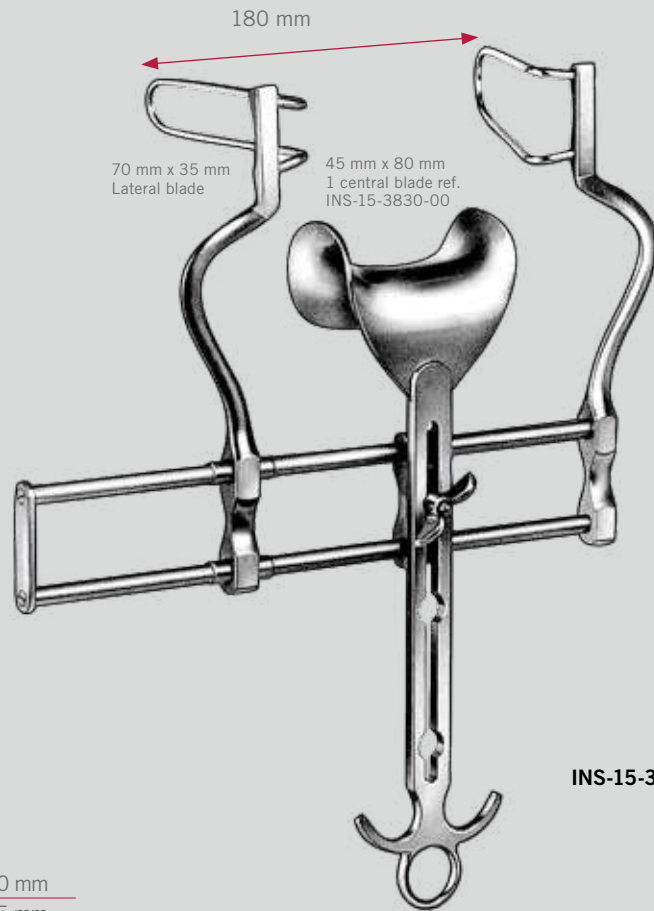

INS-15-3815-00

Balfour

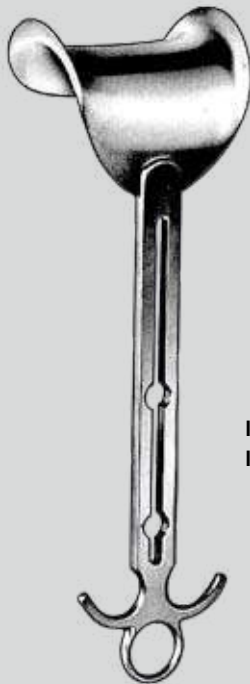

INS-15-3830-00 45 x 80 mm

INS-15-3831-00 70 x 85 mm

Mead



INS-0200-22
Spare discs plastic, pair
for INS-0200-20

INS-0200-20 185 g, 19 cm
Mead mallet
Ø 20 mm



INS-0201-99
Spare discs plastic, pair
for INS-0201-25

INS-0201-25 140 g, 18,5 cm
Mallet with plastic discs
Ø 25 mm

Cottle



one side flat,
one side round

INS-0202-30 240 g, 19 cm
Cottle mallet
Ø 30 mm

Hajek



Lead filled head

INS-0203-22 80 g, 16 cm
Mallet filled with plumb
Ø 22 mm



Lead filled head

INS-0204-22 165 g, 19 cm
Mallet filled with plumb
Ø 22 mm



INS-0205-27 140 g, 22 cm
Hajek mallet
Ø 27 mm

Wagner



INS-0206-32
Spare discs, pair
for INS-0206-30

INS-0206-30 215 g, 25 cm
Mallet with plastic discs
Ø 30 mm



INS-0208-35 170 / 260 g, 24,5 cm
Wagner mallet
Ø 35 mm
complete with 1 pair metal-
and plastic discs,
include wrench



INS-0208-38
Wrench for Wagner mallet
INS-0208-35



INS-0208-36
Spare discs metal, pair flat
and round for INS-0208-35



INS-0208-37
Spare discs plastic, pair flat
and round for INS-0208-35

Bergmann

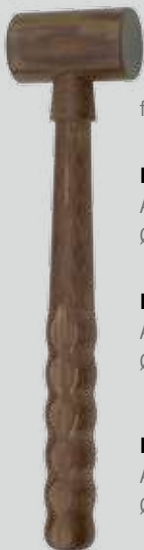

from artificial wood

INS-0210-35 120 g, 26 cm
Artificial wood mallet
Ø 35 mm

INS-0210-42 170 g, 26 cm
Artificial wood mallet
Ø 42 mm

INS-0210-50 220 g, 26 cm
Artificial wood mallet
Ø 50 mm



INS-0211-30 300 g, 23,5 cm
Bergmann mallet
Ø 30 mm

Bergmann



INS-0211-45 300 g, 25 cm
Bergmann mallet
Ø 45 mm

Ombredanne



INS-0212-42 400 g, 25 cm
Mallet
Ø 29 / 42 mm



INS-0213-40 550 g, 25 cm
Ombredanne mallet
Ø 40 mm

Heath



copper filled head

INS-0214-40 600 g, 18,5 cm
Heath mallet
Ø 40 mm

INS-0214-45 1000 g, 20 cm
Heath mallet
Ø 45 mm

Williger



INS-0215-26 300 g, 24 cm
Williger mallet
Ø 26 mm

INS-0215-28 340 g, 24 cm
Williger mallet
Ø 28 mm

INS-0215-30 400 g, 24 cm
Williger mallet
Ø 30 mm

Doyen



INS-0216-25 120 g, 19,5 cm
Doyen mallet
Ø 25 mm

INS-0216-30 180 g, 19,5 cm
Doyen mallet
Ø 30 mm

INS-0216-35 260 g, 19,5 cm
Doyen mallet
Ø 35 mm

Collin



INS-0217-30 220 g, 20 cm
Collin mallet
Ø 20 mm

Lucae



INS-0218-19 230 g, 19,5 cm
Lucae mallet
Ø 19 mm

INS-0218-25 260 g, 19,5 cm
Lucae mallet
Ø 25 mm



INS-0219-20 140 g, 16,5 cm
Mallet filled with plumb
Ø 20 mm

INS-0219-21 140g, 16,5 cm
Mallet filled with brass
Ø 20 mm

Gerzog



lead filled head

INS-0220-01 210 g, 19 cm
Gerzog mallet filled
with plumb, Ø 25 mm

Kirk



INS-0220-02 700 g, 21 cm
Kirk mallet
Ø 40 mm



INS-0221-30 510 g, 26 cm
Mallet with plastic handle
Ø 30 mm

Partsch



INS-0222-22 200 g, 19 cm
Partsch mallet
Ø 22 mm

Steinbach



from artifical wood

INS-0223-60 400 g, 24 cm
Steinbach artificial wood mallet
Ø 80 x 60 mm



from artifical wood

INS-0224-42 400 g, 26 cm
Artificial wood mallet, filled with plumb
Ø 42 mm

INS-0225-42 250 g, 26 cm
Artificial wood mallet,
Ø 42 mm



from artifical wood

INS-0226-42 400 g, 26 cm
Artificial wood mallet filled with plumb and metal rings on head
Ø 42 mm



from artifical wood

INS-0227-30 125 g, 22 cm
Artificial wood mallet,
Ø 30 mm

INS-0228-42 530 g, 26 cm
Mallet with plastic handle
Ø 42 / 30 mm



INS-0229-99
PTFE-spare discs, pair
for INS-0229-29

INS-0229-29 675 g, 26,5 cm
Mallet with plastic handle,
discs flat / round
Ø 30 mm



INS-0230-45 450 g, 26,5 cm
Mallet with plastic handle
Ø 30 mm



INS-0230-90 P 900 g, 26,5 cm
Mallet with
PROPYLUX® Handle
Ø 50 mm

INS-0230-90 900 g, 26,5 cm
Mallet with plastic handle
Ø 50 mm



INS-0231-48 480 g, 24 cm
Mallet with plastic handle
Ø 30 mm



INS-0232-42
Spare discs, Pair,
for INS-0232-37

INS-0232-37 370 g, 24 cm
Mallet with plastic handle,
with spare discs
Ø 37 mm



INS-0234-35 390 g, 24 cm
Mallet with plastic handle
Ø 32 mm

INS-0234-50 540 g, 24 cm
Mallet with plastic handle
Ø 35 mm

INS-0234-70 740 g, 24 cm
Mallet with plastic handle
Ø 40 mm



INS-0235-00 425 g, 23,5 cm
Mallet with head material
from implant steel
Ø 27 / 13,5 mm,
ISO 5832-1 implant steel



INS-0236-23 264 g, 23 cm
Mallet with hook handle

Putti



INS-23-3230-30 30 cm / 12"

Putti



INS-23-3235-27 27 cm / 10½"

Fomon

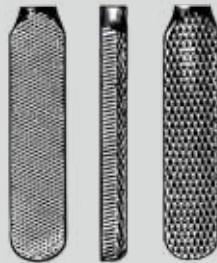
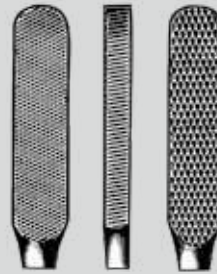

INS-23-3240-21 21 cm / 8¼"

Double ended, fine and coarse teeth
4-side, convex and flat blades
8 mm width

Murphy-Lane



INS-23-3245-30 30 cm / 12"

Bone skid

Trochlear



INS-23-3250-17 17 cm / 6½"



Maltz Improved



INS-23-3255-21 21 cm / 8¼"

Double ended,
forward and
backward
cutting,
8 mm width



Aufricht



INS-23-3260-21 21 cm / 8¼"

Single ended
forward cutting
9 mm width



INS-23-3261-21

Single ended
backward cutting
9 mm width

Maltz



INS-23-3265-18 18 cm / 7"

34 x 7 mm
Backward cutting
Single ended
10 mm width

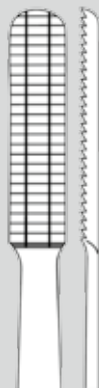
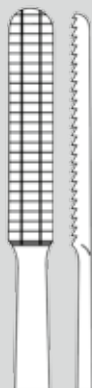

INS-23-3266-18

34 x 7 mm
Forward cutting
Single ended
10 mm width



Excision Arthroplasty

INS-23-3270-17 17 cm / 6½"

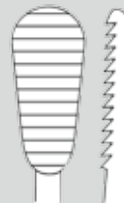

Joseph



INS-23-3275-16 16 cm / 6¼"

Single ended,
8 mm at wide
point, fine
cross serrations

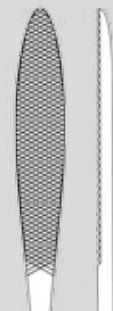

Lewis Rasp



INS-23-3280-19 19 cm / 7½"
Fine, single ended
8 mm width



INS-23-3281-19
Coarse, single ended
8 mm width
plain serrations

Cottle Rasp



INS-23-3285-20 20.5 cm / 8"
Single ended
backward cutting
9 mm width
plain serrations



Miller-Colburn

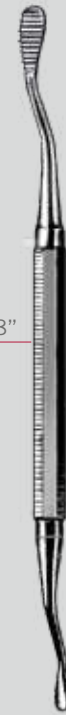

INS-23-0591-01 18 cm / 7"
Double ended,
plain serrations



7 mm

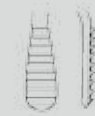

5 mm

Miller-Colburn



INS-23-3290-18 18 cm / 7"
Double ended,
5 mm width



Cross serrations

Plain serrations

Miller-Colburn



INS-23-3295-18 18 cm / 7"
Double ended,
cross serrations



7 mm

5 mm

Miller-Colburn



INS-23-3301-21 21.5 cm / 8½"
Double ended,
13 mm width
Cross serrations,
for rapid
shaping of bone



Fine serrations

Coarse serrations

Miller-Colburn

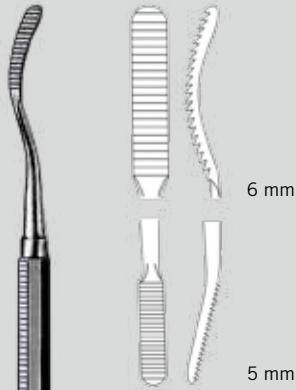

INS-23-0591-02 18.5 cm / 7¼"
Double ended,
plain serrations

Miller-Colburn

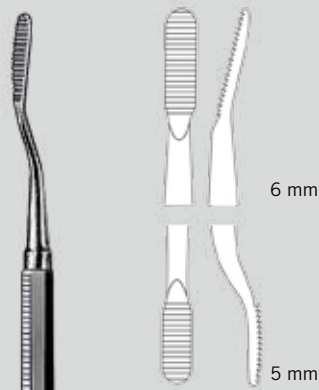

INS-23-0591-04 18 cm / 7"
Double ended,
plain serrations

Miller-Colburn

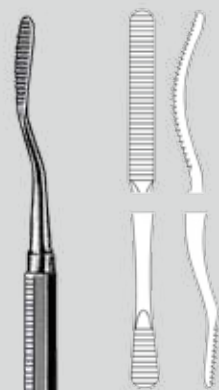

INS-23-0591-03 18 cm / 7"
Double ended,
5 mm width,
plain serrations

Polokoff Rasp

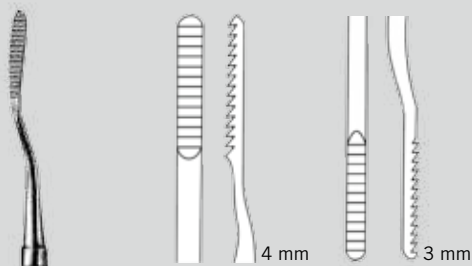

INS-23-3305-18 18 cm / 7"
Double ended,
plain serrations

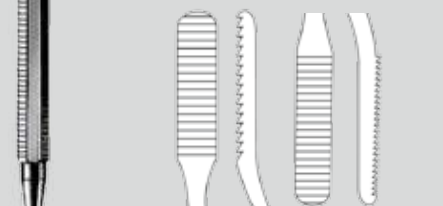

INS-23-3305-21 21.5 cm / 8½"
6 mm width
Double ended,
plain serrations

Miller-Colburn

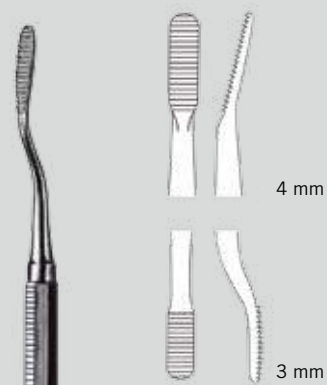

INS-23-3310-18 18 cm / 7"
Double ended

Gigli



INS-23-3355-00
Handle

Olivecrona

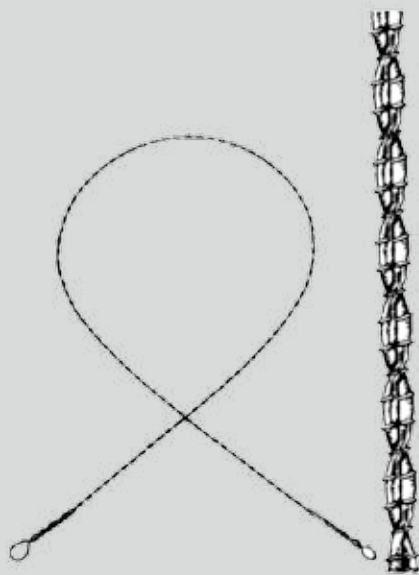

INS-23-3345-30 30 cm / 12"
INS-23-3345-40 40 cm / 16"
INS-23-3345-50 50 cm / 20"
INS-23-3345-70 70 cm / 28"



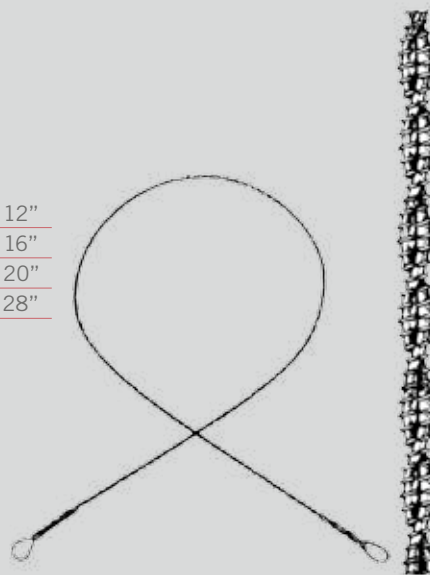







Gigli



INS-23-3350-30 30 cm / 12"
INS-23-3350-40 40 cm / 16"
INS-23-3350-50 50 cm / 20"
INS-23-3351-50 50 cm / 20"
Fine, 6 wires twisted





Volkman



	
INS-23-0405-40 17 cm / 6¾"	INS-23-0405-30
Fig. 0000	Fig. 000
	
INS-23-0405-20 17 cm / 6¾"	INS-23-0405-10
Fig. 00	Fig. 0
	
INS-23-0405-01 17 cm / 6¾"	INS-23-0405-02
Fig. 1	Fig. 2
	
INS-23-0405-03 17 cm / 6¾"	INS-23-0405-04
Fig. 3	Fig. 4
	
INS-23-0405-05 17 cm / 6¾"	INS-23-0405-06
Fig. 5	Fig. 6











Spratt



	
INS-23-3630-40 17 cm / 6¾"	INS-23-3630-30
Fig. 0000	Fig. 000
	
INS-23-3630-20 17 cm / 6¾"	INS-23-3630-10
Fig. 00	Fig. 0
	
INS-23-3630-01 17 cm / 6¾"	INS-23-3630-02
Fig. 1	Fig. 2
	
INS-23-3630-03 17 cm / 6¾"	INS-23-3630-04
Fig. 3	Fig. 4
	
INS-23-3630-05 17 cm / 6¾"	INS-23-3630-06
Fig. 5	Fig. 6

Bruns



				
INS-23-0409-40 17 cm / 6¾"	INS-23-0409-30 17 cm / 6¾"	INS-23-0409-20 17 cm / 6¾"	INS-23-0409-10 17 cm / 6¾"	INS-23-0409-01
Fig. 0000	Fig. 000	Fig. 00	Fig. 0	Fig. 1
				
INS-23-0409-02 17 cm / 6¾"	INS-23-0409-03 17 cm / 6¾"	INS-23-0409-04 17 cm / 6¾"	INS-23-0409-05 17 cm / 6¾"	INS-23-0409-06
Fig. 2	Fig. 3	Fig. 4	Fig. 5	Fig. 6

ORTHOPEDIC. Bone Osteotomes Chisels And Gouges

Leibinger
Osteotomes



INS-23-3710-13 13.5 cm / 5¼"
8 mm



INS-23-3711-13 13.5 cm / 5¼"
10 mm



INS-23-3715-13 13.5 cm / 5¼"
8 mm



INS-23-3716-13 13.5 cm / 5¼"
10 mm



INS-23-3720-13 13.5 cm / 5¼"
8 mm



INS-23-3721-13 13.5 cm / 5¼"
10 mm



INS-23-3712-13 13.5 cm / 5¼"
12 mm



INS-23-3713-13 13.5 cm / 5¼"
14 mm



INS-23-3717-13 13.5 cm / 5¼"
12 mm



INS-23-3718-13 13.5 cm / 5¼"
14 mm



INS-23-3722-13 13.5 cm / 5¼"
12 mm



INS-23-3723-13 13.5 cm / 5¼"
14 mm



INS-23-3714-13 13.5 cm / 5¼"
16 mm



INS-23-3719-13 13.5 cm / 5¼"
16 mm



INS-23-3724-13 13.5 cm / 5¼"
16 mm

Leibinger
Chisels



INS- 23-0206-02 13.5 cm / 5¼"
2 mm



INS- 23-0206-03 13.5 cm / 5¼"
3 mm



INS- 23-0206-04 13.5 cm / 5¼"
4 mm



INS- 23-0206-05 13.5 cm / 5¼"
5 mm



INS- 23-0206-06 13.5 cm / 5¼"
6 mm



INS- 23-0207-02 17 cm / 6¾"
2 mm



INS- 23-0207-03 17 cm / 6¾"
3 mm



INS- 23-0207-04 17 cm / 6¾"
4 mm



INS- 23-0207-05 17 cm / 6¾"
5 mm



INS- 23-0207-06 17 cm / 6¾"
6 mm

Leibinger
Gouges



INS- 23-0210-02 13.5 cm / 5¼"
2 mm



INS- 23-0210-03 13.5 cm / 5¼"
3 mm



INS- 23-0210-04 13.5 cm / 5¼"
4 mm



INS- 23-0210-05 13.5 cm / 5¼"
5 mm



INS- 23-0210-06 13.5 cm / 5¼"
6 mm



INS- 23-0211-02 17 cm / 6¾"
2 mm



INS- 23-0211-03 17 cm / 6¾"
3 mm



INS- 23-0211-04 17 cm / 6¾"
4 mm



INS- 23-0211-05 17 cm / 6¾"
5 mm



INS- 23-0211-06 17 cm / 6¾"
6 mm

Mini-Lambotte

Osteotome

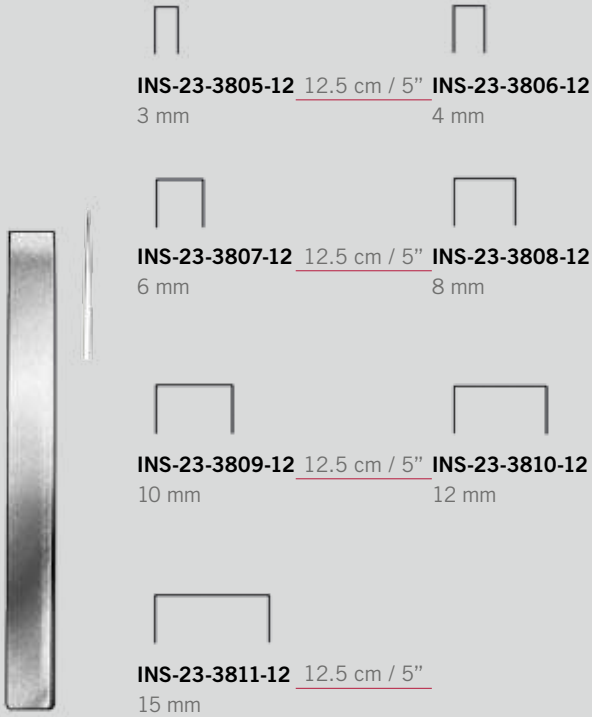

Mini-Lambotte

Osteotome

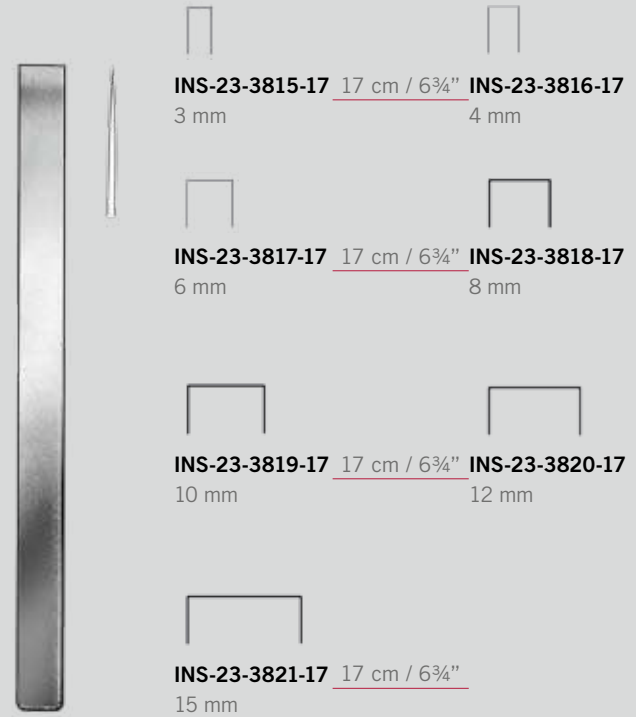

Mini-Lambotte

Osteotome

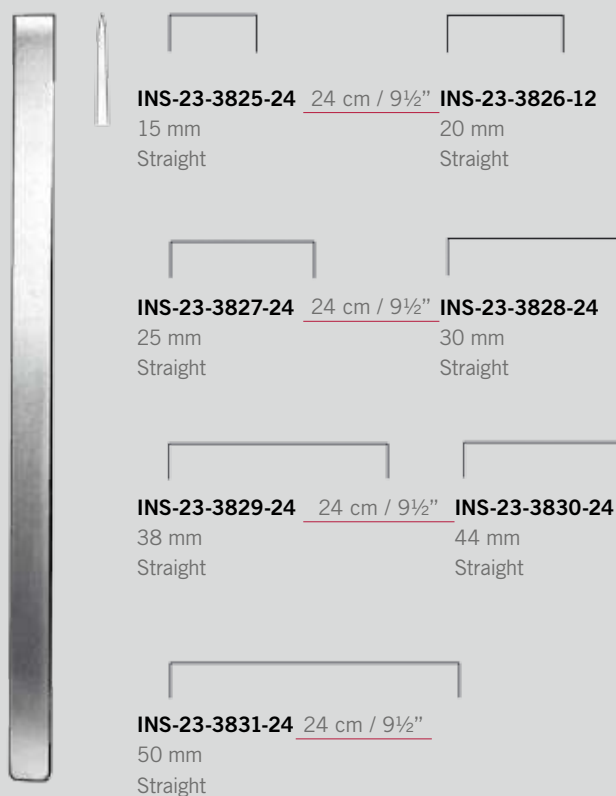

Mini-Lambotte

Osteotome

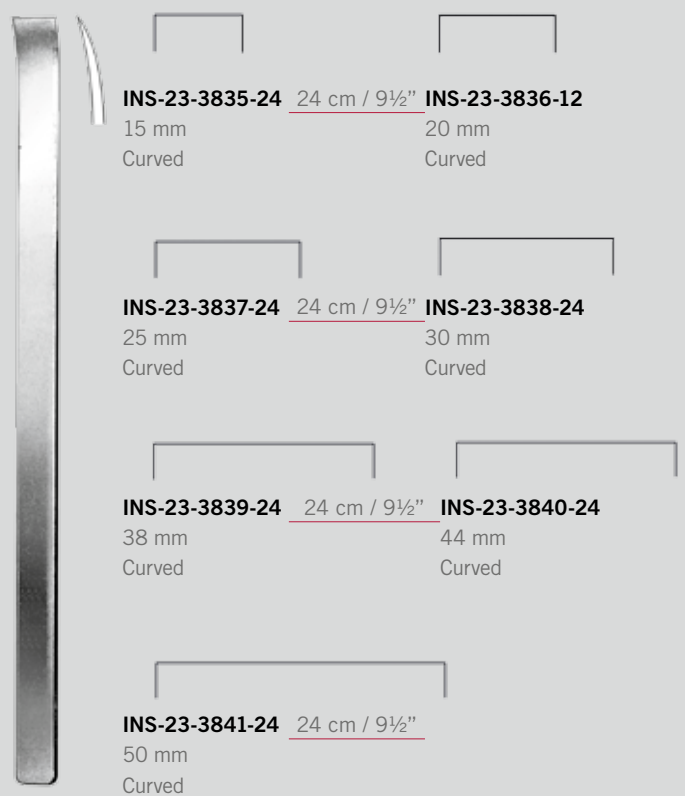

Williger



- INS-23-4415-16** 16 cm / 6¼"
4 mm
- INS-23-4416-16** 16 cm / 6¼"
5 mm
- INS-23-4417-16** 16 cm / 6¼"
6 mm
- INS-23-4418-16** 16 cm / 6¼"
7 mm

Langenbeck



- INS-23-4420-20** 20 cm / 8"
8 mm
- INS-23-4421-20** 20 cm / 8"
10 mm

Lambotte



- 8 mm
- INS-23-4445-17** 17 cm / 6¾"

Langenbeck



- INS-23-4450-17** 17 cm / 6¾"
5 mm



- INS-23-4451-17**
7 mm



- INS-23-4450-20** 20 cm / 8"
8 mm



- INS-23-4451-20**
10 mm

Adson



- INS-23-4455-17** 17 cm / 6¾"



- INS-23-4456-17**



- INS-23-4457-17** 17 cm / 6¾"



- INS-23-4458-17**

Periosteal Elevator

Ferrozell handle



INS-23-4550-18 18 cm / 7"

Periosteal Elevator

Ferrozell handle



INS-23-4555-18 18 cm / 7"

Periosteal Elevator

Ferrozell handle



INS-23-4560-18 18 cm / 7"

Periosteal Elevator

Ferrozell handle



INS-23-4565-20 20 cm / 8"

Periosteal Elevator

Ferrozell handle



INS-23-4570-20 20 cm / 8"

Periosteal Elevator

Ferrozell handle



INS-23-4575-20 20 cm / 8"

Bone Lever



INS-23-4580-00 16 cm

Bone Lever



INS-23-4585-14 14 cm / 5½"

Bone Lever



INS-23-4590-15 15 cm / 6"
5 mm

Bone Lever



INS-23-4595-15 15 cm / 6"
7 mm

Buck-Gramcko

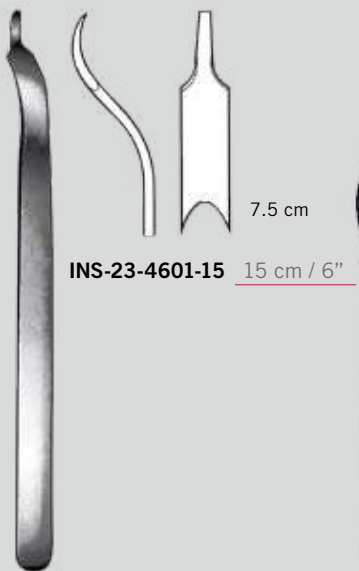

INS-23-4601-15 15 cm / 6"
7.5 cm

Freer



INS-23-4605-00 15 cm



INS-23-4615-18 18.5 cm / 7¼"
Sharp/Blunt

Mini-Hohmann

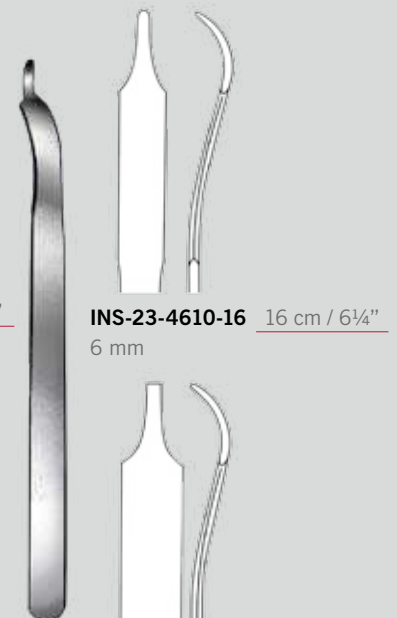

INS-23-4610-16 16 cm / 6¼"
6 mm



INS-23-4611-16 16 cm / 6¼"
8 mm

Hohmann



INS-23-4620-00 22 cm / 8¾"
8 mm

Hohmann

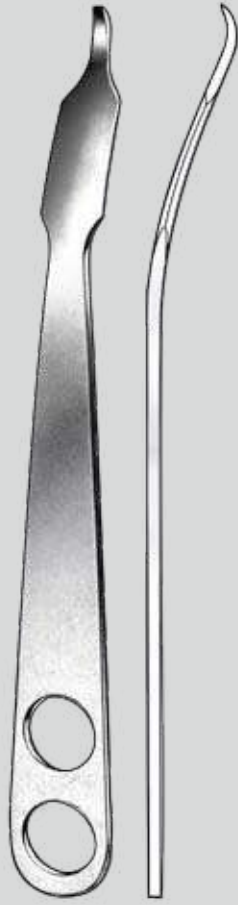

INS-23-4625-00 23.5 cm / 9¼"
18 mm

Hohmann



INS-23-4630-00 23.5 cm / 9¼"
43 mm

Hohmann



INS-23-4635-00 23.5 cm / 9¼"
70 mm

Reposition Forceps

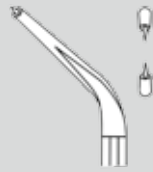

INS-23-4755-09 9.5 cm / 3¾"
Stepped tips

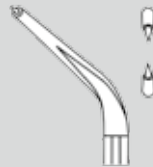

INS-23-4756-09 9.5 cm / 3¾"
Stepped tips

Bone Reduction Forceps

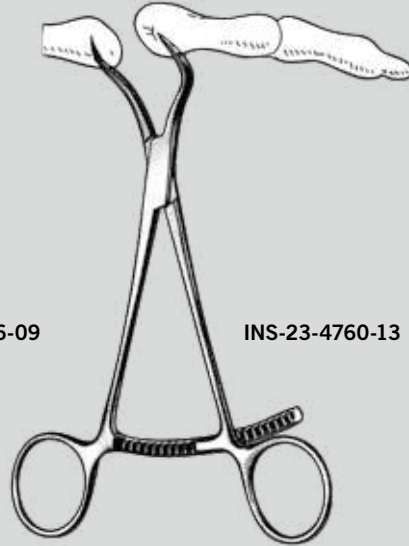

INS-23-4760-13 13.5 cm / 5½"

Reposition Forceps

Brand

Bone Reduction Forceps



INS-23-4765-13 13.5 cm / 5¼"
Especially for
maxillary reposition

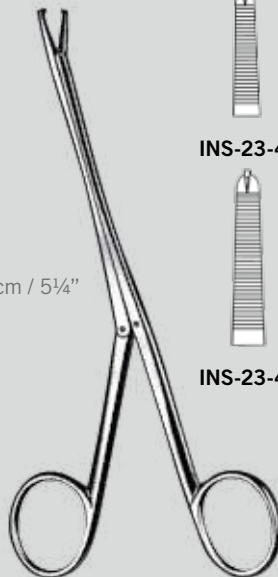

INS-23-4745-15 15 cm / 6"

INS-23-4745-19 19 cm / 7½"

INS-23-4745-24 24 cm / 9½"

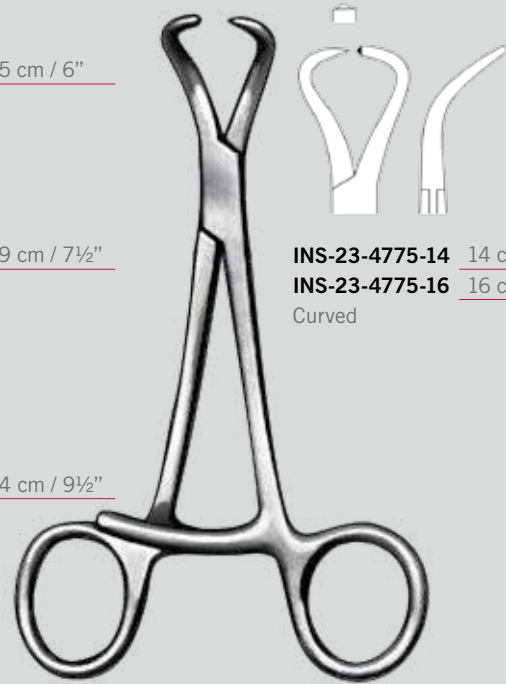

INS-23-4775-14 14 cm / 5½"
INS-23-4775-16 16 cm / 6½"
Curved

Stagbeetle



INS-23-4780-12 12 cm / 4¾"
Bone Reduction Forceps
Curved,
pointed tips

Bone Reduction Forceps

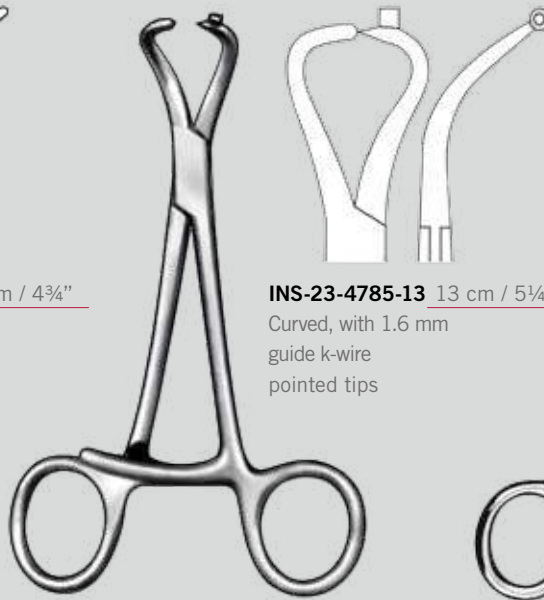

INS-23-4785-13 13 cm / 5¼"
Curved, with 1.6 mm
guide k-wire
pointed tips

Bone Holding Forceps

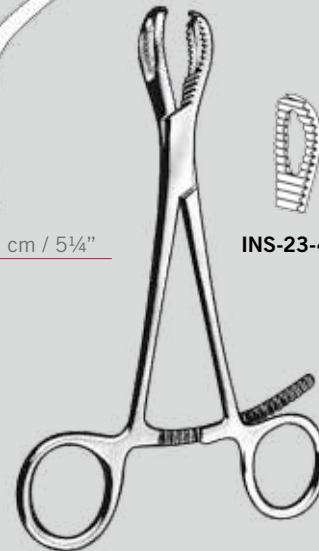

INS-23-4790-00 16 cm / 6½"

Bone Reduction Forceps



INS-23-4795-17 17 cm / 6¾"
Curved,
with 1.1 mm
k-wire guide

Bone Reduction Forceps

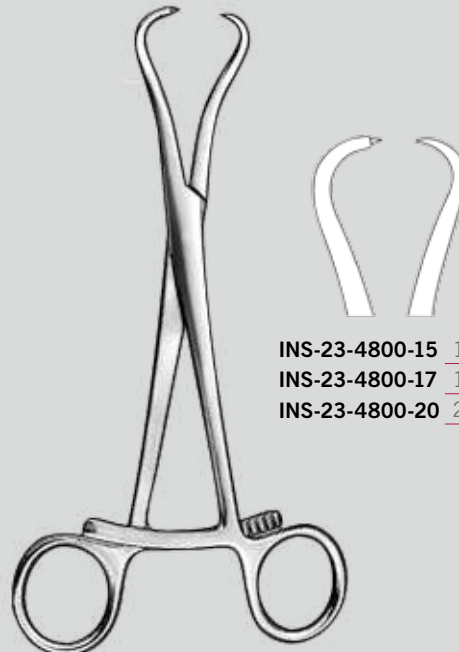

INS-23-4800-15 15 cm / 6"
INS-23-4800-17 17.5 cm / 7"
INS-23-4800-20 20 cm / 8"

Bone Holding Forceps



INS-23-4805-12 12.5 cm / 5"
Serrated
10 Teeth

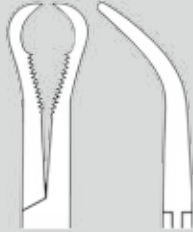

INS-23-4805-14 14 cm / 5½"
Serrated
14 Teeth

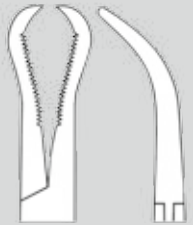

Reill



INS-23-4810-17 17.5 cm / 7"
Reposition Forceps
curved,
pointed tips

Steinhauser

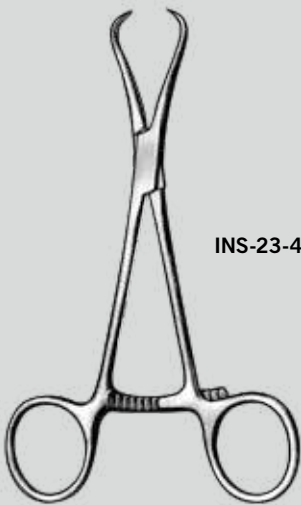

INS-23-4815-13 13 cm / 5"

Steinhauser

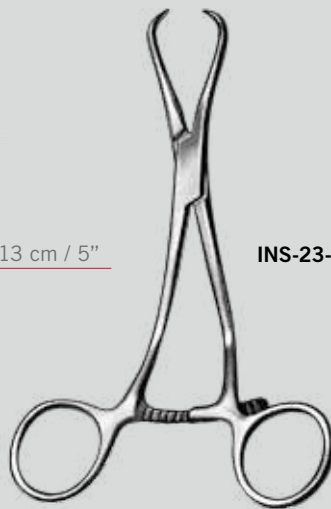

INS-23-4820-13 13 cm / 5"

Bone Fragment Forceps

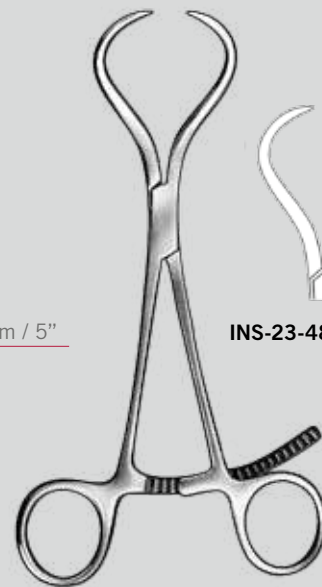

INS-23-4825-16 16 cm / 6¼"

Bone Reduction Forceps

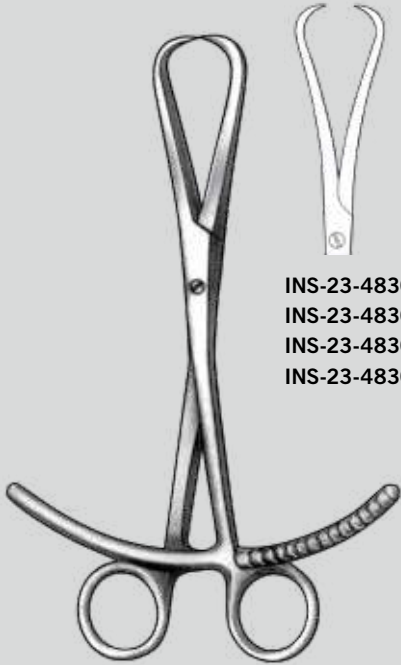

- INS-23-4830-15** 15 cm / 6"
- INS-23-4830-18** 18 cm / 7"
- INS-23-4830-20** 20 cm / 8"
- INS-23-4830-30** 30 cm / 12"

Bone Grasping Forceps

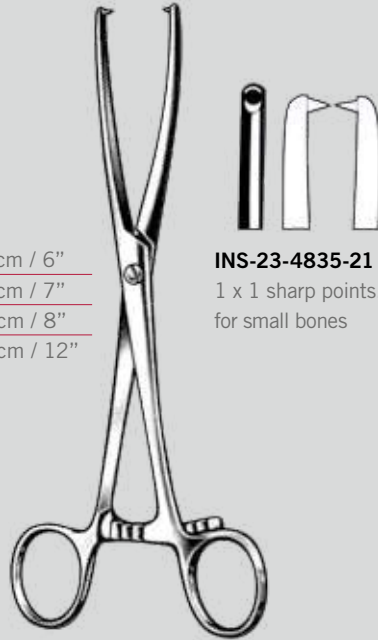

- INS-23-4835-21** 21 cm / 8¼"
1 x 1 sharp points.
for small bones

Meyer

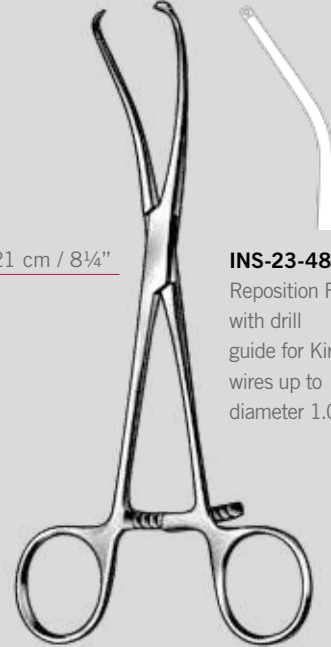

- INS-23-4840-17** 17 cm / 6¾"
Reposition Forceps
with drill
guide for Kirschner
wires up to
diameter 1.0 mm

Meyer



- INS-23-4845-20** 20.5 cm / 8"
Reposition Forceps
with drill guide
for kirschner
wires up to
diameter 2.0 mm

Bone Holding Forceps



- INS-23-4850-14** 14 cm / 5½"

Locke



- INS-23-4855-15** 15 cm / 6"
Phalangeal forceps
serrated jaws
1:1 Teeth

Bone Reduction Forceps



INS-23-4860-14 14 cm / 5 1/4"
for small bones
curved,
ratchet length 1 1/4"

Bone Grasping Forceps

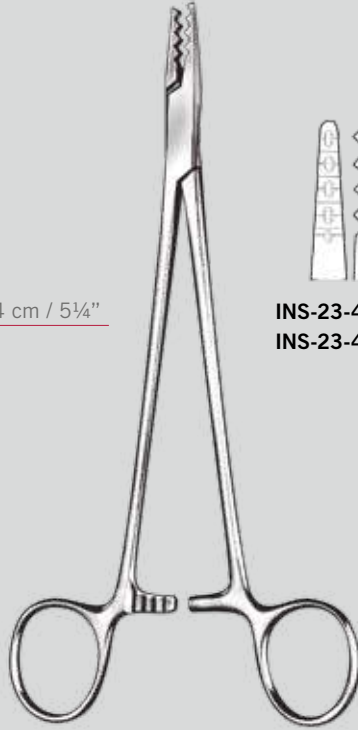

INS-23-4870-14 14 cm / 5"
INS-23-4870-19 19 cm / 7 1/2"

Lewin

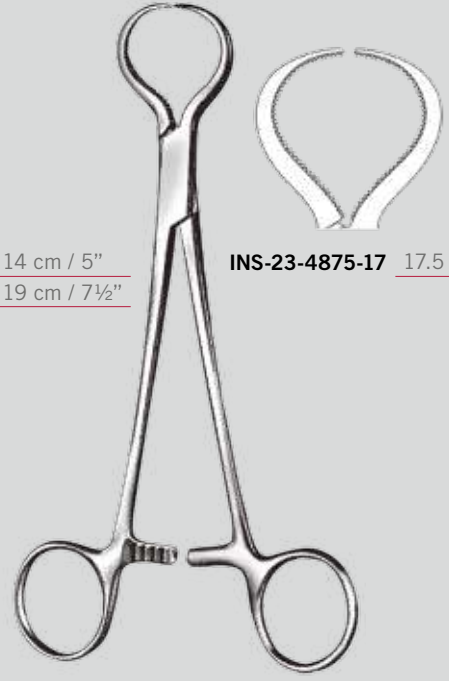

INS-23-4875-17 17.5 cm / 7"

Dingmann



INS-23-4880-18 18.5 cm / 7 1/4"
Delicate

Dingmann



INS-23-4885-18 18.5 cm / 7 1/4"
Standard

Verbrugge



INS-23-4980-16 16 cm / 6¼" Both jaws serrated
INS-23-4981-16 1 jaw serrated, 1 jaw plain

Verbrugge



INS-23-4985-18 18 cm / 7"
INS-23-4985-24 24 cm / 9½"
INS-23-4985-26 26 cm / 10¼"
INS-23-4985-28 28 cm / 11"
 Serrated jaws

Kern



INS-23-4945-12 12 cm / 4¾"
INS-23-4945-15 15 cm / 6"
INS-23-4945-17 17 cm / 6¾"
INS-23-4945-21 21 cm / 8¼"
 Without ratchet

Kern



INS-23-4950-12 12 cm / 4¾"
INS-23-4950-15 15 cm / 6"
INS-23-4950-17 17 cm / 6¾"
INS-23-4950-21 21 cm / 8¼"
INS-23-4950-23 23 cm / 9"
 With ratchet

Bone Holding Forceps

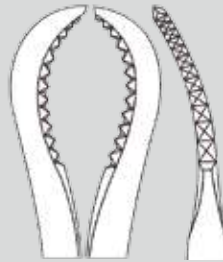

INS-23-5005-16	<u>16 cm / 6¼"</u>
INS-23-5005-18	<u>18 cm / 7"</u>
INS-23-5005-20	<u>20 cm / 8"</u>
INS-23-5005-22	<u>22 cm / 9"</u>
INS-23-5005-24	<u>24 cm / 9½"</u>
INS-23-5005-26	<u>26 cm / 10¼"</u>
INS-23-5005-28	<u>28 cm / 11"</u>

Patella Forceps



INS-23-5010-18	<u>18 cm / 7"</u>
2 x 2 sharp teeth with speed lock	

ORTHOPEDIC. Bone Holding Forceps



2.5mm

INS-23-5025-15 15 cm / 6" **INS-23-5026-15** 15 cm / 6" **INS-23-5027-15**
Standard jaws Reverse jaws Moveable jaws



6.5mm

INS-23-5025-19 19 cm / 7½" **INS-23-5026-19** 19 cm / 7½" **INS-23-5027-19**
Standard jaws Reverse jaws Moveable jaws



9.5mm

INS-23-5025-24 24 cm / 9½" **INS-23-5026-24** 24 cm / 9½" **INS-23-5027-24**
Standard jaws Reverse jaws Moveable jaws



10 mm

INS-23-5025-26 26 cm / 10¼" **INS-23-5026-26** 26 cm / 10¼" **INS-23-5027-26**
Standard jaws Reverse jaws Moveable jaws



8.5mm

INS-23-5025-22 22 cm / 8½" **INS-23-5026-22** 22 cm / 8½" **INS-23-5027-22**
Standard jaws Reverse jaws Moveable jaws



11mm

INS-23-5025-28 28 cm / 11" **INS-23-5026-28** 28 cm / 11" **INS-23-5027-28**
Standard jaws Reverse jaws Moveable jaws

Self-Centering Forceps

Self-Centering Forceps

Verbrugge



Standard jaws



With thread fixation Reverse jaws

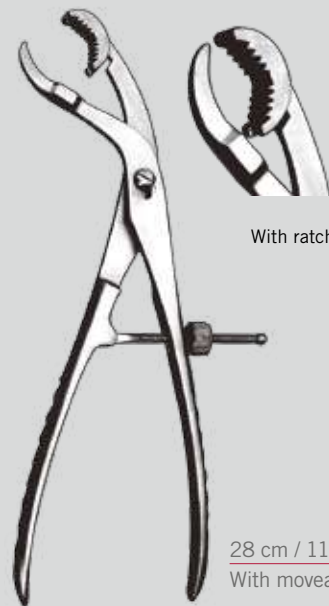

With ratchet

28 cm / 11"
With moveable jaws

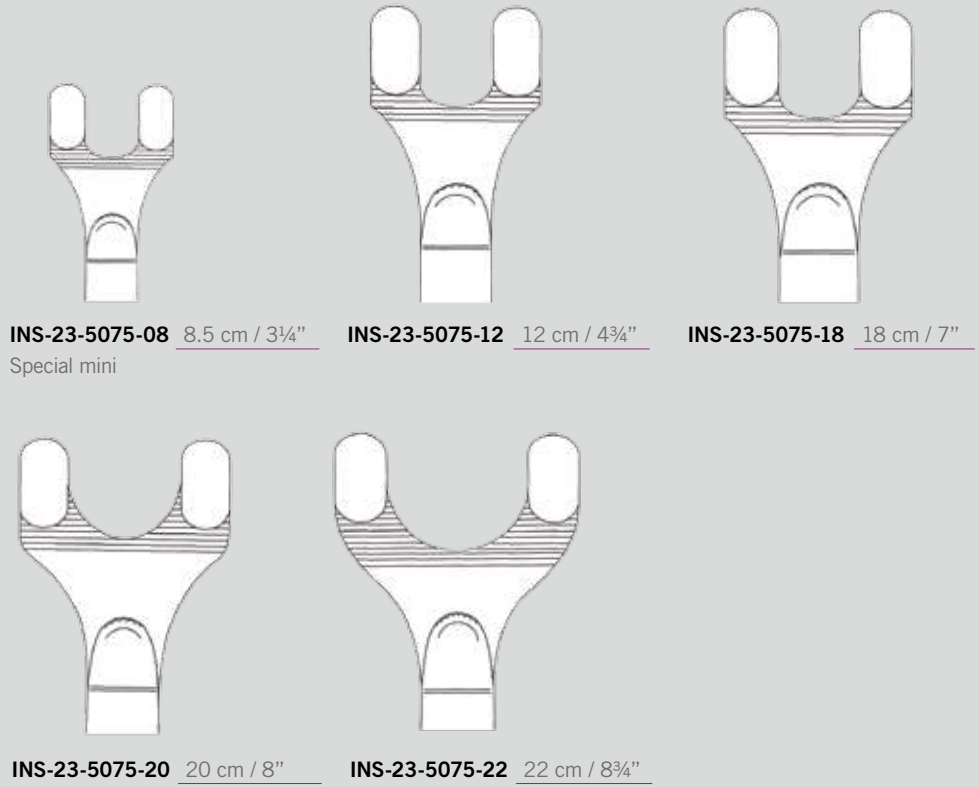
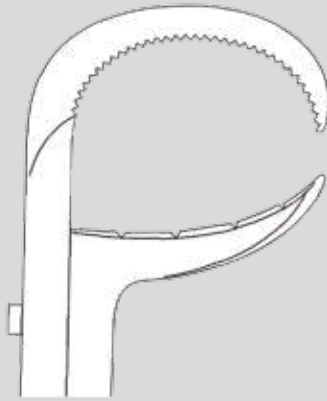

Gerster - Lowmann
1 x 2 jaws



Gerster
Traction Bar

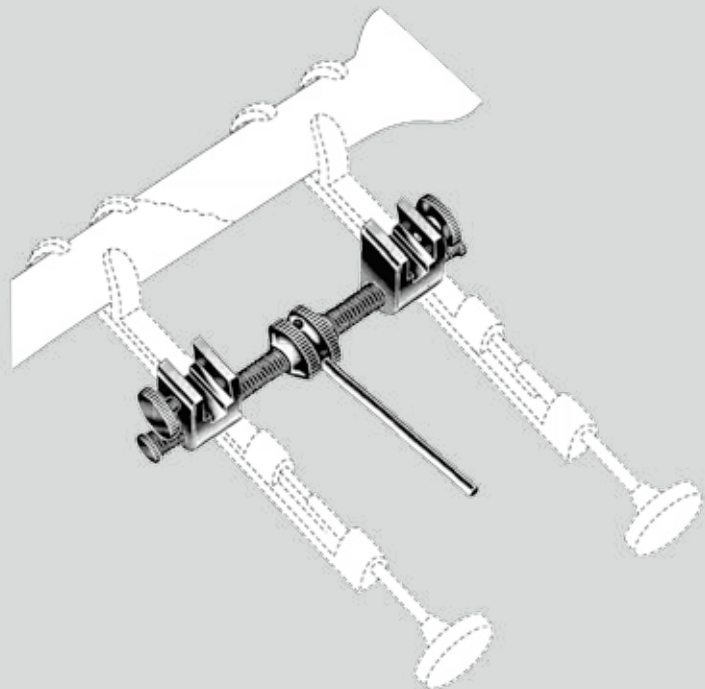

INS-23-5080-00

Lowmann

1 x 1 jaws



- INS-23-5085-12** 12 cm / 4¾"
- INS-23-5085-18** 18 cm / 7¼"
- INS-23-5085-20** 20 cm / 8"

Bone clamp

Lowmann

2 x 2 jaws

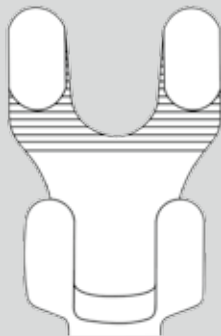

- INS-23-5090-18** 18.5 cm / 7¼"
- INS-23-5090-20** 20 cm / 8"

Bone clamp
Moveable Jaws

Lowman Hoglund

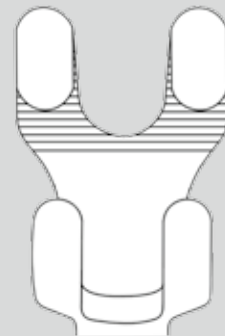

- INS-23-5095-12** 12 cm / 4¾"
- INS-23-5095-18** 18 cm / 7¼"
- INS-23-5095-20** 20 cm / 8"

Mini-Friedmann



INS-23-0900-12 12.5 cm / 5"

Friedmann



INS-23-0902-14 14 cm / 5½"

Micro-Friedmann
Delicate



INS-23-5140-15 15 cm / 6"
Straight
2 x 6 mm bite

INS-23-5141-15
Curved
2 x 6 mm bite

Micro-Friedmann

Extremely delicate

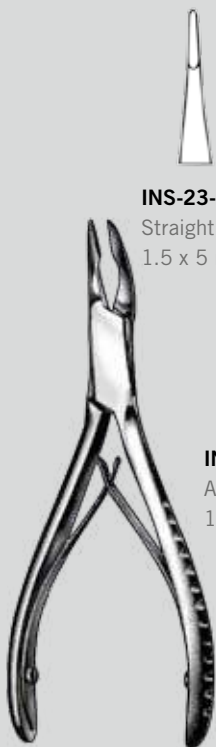

INS-23-5145-14 14 cm / 5½" Straight
1.5 x 5 mm bite

INS-23-5146-14 Angled 30°
1.5 x 5 mm bite

INS-23-5147-14 14 cm / 5½"
Angled 90°
1.5 x 5 mm bite

Stellbrink



INS-23-5150-17 17 cm / 6¾"

INS-23-5151-17

Universal



INS-23-5155-13 13.5 cm / 5¼"

Mead



INS-23-5160-16 16.5 cm / 6 1/2"

Mead



INS-23-5165-16 16.5 cm / 6 1/2"

Mead

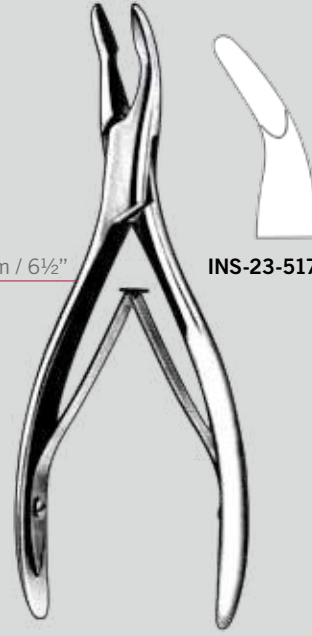

INS-23-5170-16 16.5 cm / 6 1/2"

Cleveland



INS-23-0906-14 14.5 cm / 5 1/2"

Cleveland



INS-23-0908-17 17 cm / 6 3/4"

Hartmann



INS-23-0920-18 18.5 cm / 7 1/4"

Jansen

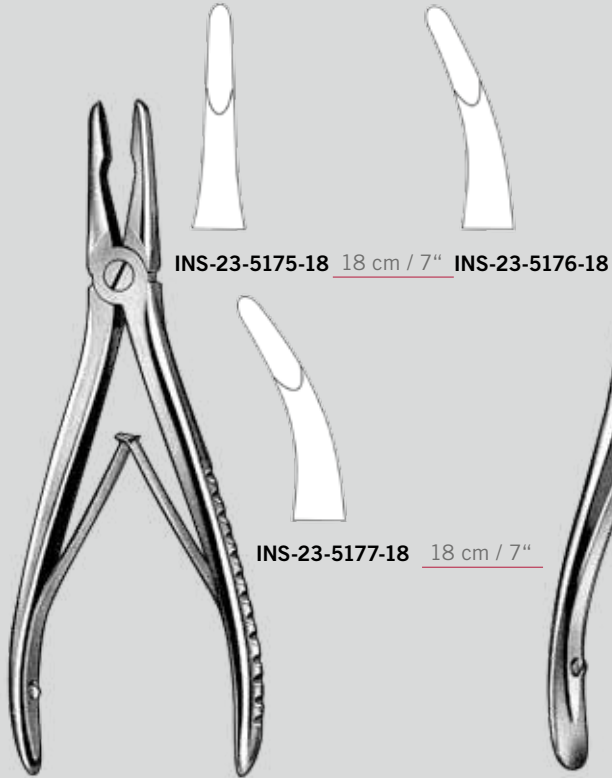

Jansen

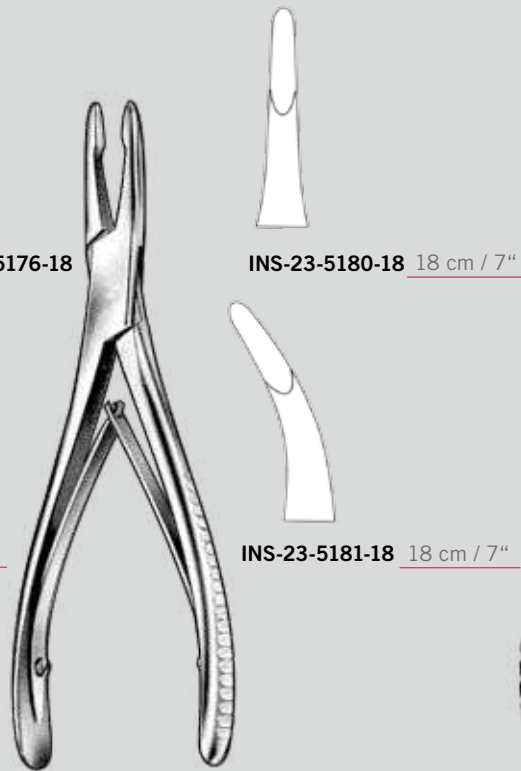

Marchac



Blumenthal

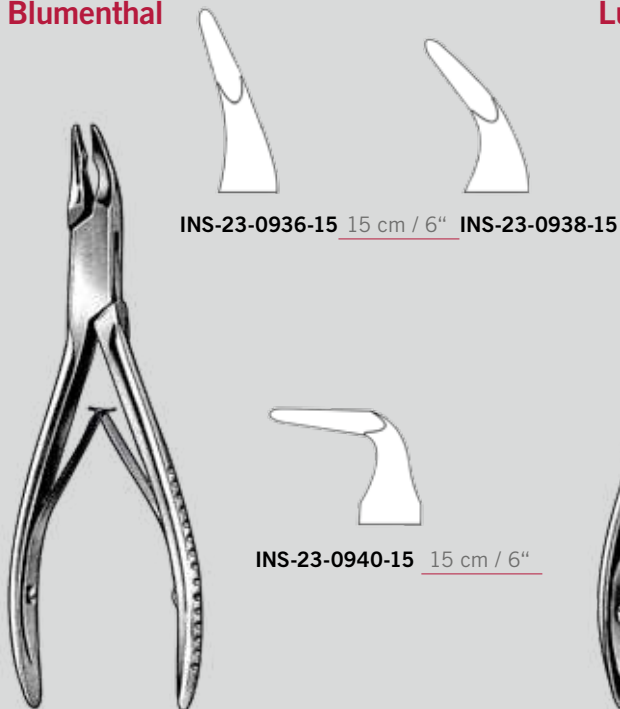

Luer

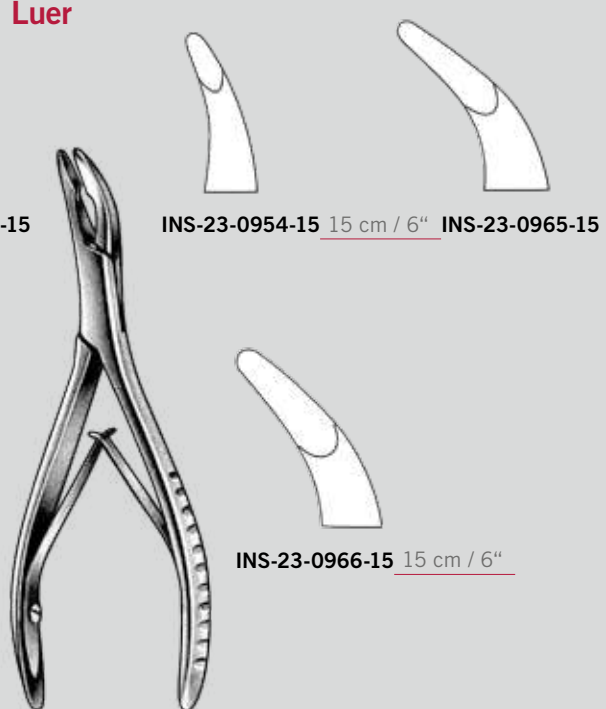

Luer



INS-23-5190-17 17 cm / 6¾"



Hakansson



INS-23-5195-17 17 cm / 6¾"
Curved to side



Alexander



INS-23-5201-14 14 cm / 5½"



Jansen

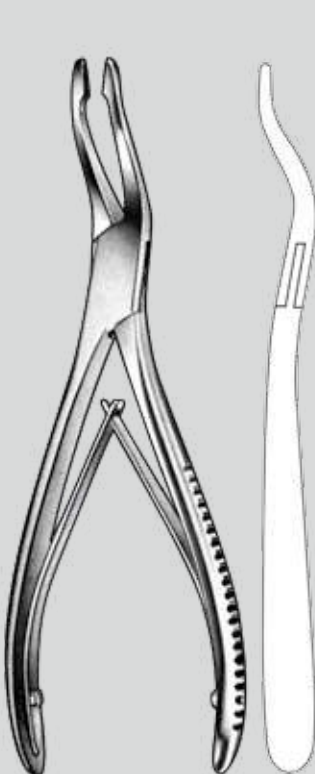

INS-23-5205-19 19 cm / 7½"



Beyer



INS-23-2145-18 18 cm / 7"



Olivecrona



INS-23-5210-20 20.5 cm / 8"



Guleke



INS-23-5215-20 20.5 cm / 8"

Trotter



INS-23-5220-20 20.5 cm / 8"
Curved to side

Northfield



INS-23-5225-20 20.5 cm / 8¼"

Pennybacker



INS-23-5230-20 20.5 cm / 8"

Wilms



INS-23-5235-21 21 cm / 8¼"

Rat Tooth Rongeur



INS-23-5240-20 20.5 cm / 8"
With teeth
8 x 15 mm bite
Straight

Lempert



INS-23-5245-16 16 cm / 6¼" **INS-23-5246-16**
INS-23-5245-19 19 cm / 7½" **INS-23-5246-19**
 Straight Curved
 2.5 mm bite 2.5 mm bite

Zaufal-Jansen



INS-23-0980-18 18 cm / 7"

Böhler



INS-23-5255-15 15 cm / 6" **INS-23-5260-15**
 2 mm tip 2 mm tip
INS-23-5256-15 15 cm / 6" **INS-23-5261-15**
 3 mm tip 3 mm tip
INS-23-5257-15 15 cm / 6" **INS-23-5262-15**
 4 mm tip 4 mm tip

Ruskin
Delicate



INS-23-2150-15 15 cm / 6" **INS-23-5295-15**
 2 mm 2 mm
INS-23-5275-15 15 cm / 6" **INS-23-5296-15**
 3 mm 3 mm
INS-23-5276-15 15 cm / 6" **INS-23-5297-15**
 4 mm 4 mm
 Straight Curved

INS-23-5280-18 17.5 cm / 7" **INS-23-5300-18**
 2 mm 2 mm
INS-23-2155-18 17.5 cm / 7" **INS-23-0988-18**
 3 mm 3 mm
INS-23-5281-18 17.5 cm / 7" **INS-23-5301-18**
 4 mm 4 mm
INS-23-5282-18 17.5 cm / 7" **INS-23-5302-18**
 6 mm 6 mm
INS-23-5283-18 17.5 cm / 7" **INS-23-5303-18**
 8 mm 8 mm
 Straight Curved

INS-23-5285-20 20 cm / 8" **INS-23-5305-20**
 2 mm 2 mm
INS-23-5286-20 20 cm / 8" **INS-23-5306-20**
 3 mm 3 mm
INS-23-5278-20 20 cm / 8" **INS-23-5307-20**
 4 mm 4 mm
INS-23-5288-20 20 cm / 8" **INS-23-5308-20**
 6 mm 6 mm
INS-23-5289-20 20 cm / 8" **INS-23-5309-20**
 8 mm 8 mm
 Straight Curved

Mayfield



INS-23-5265-17 17 cm / 6¾"

Beyer

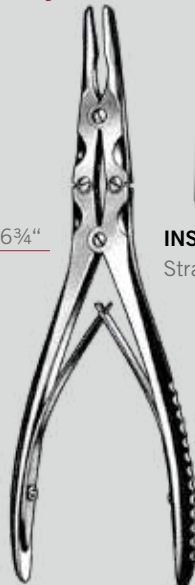

INS-23-5270-18 18 cm / 7" **INS-23-5271-18**
 Straight Curved

Ruskin



INS-23-5315-23 23 cm / 9"

Smith-Peterson

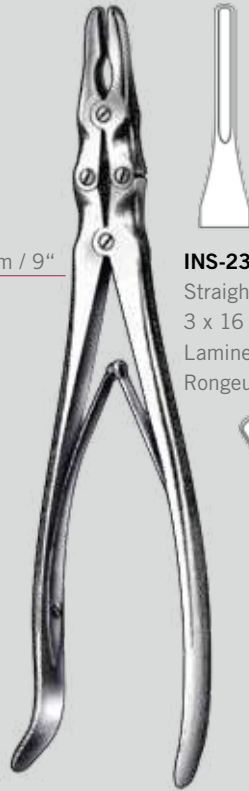

INS-23-5320-24 24 cm / 9½"

Straight
3 x 16 mm bite
Laminectomy
Rongeur



INS-23-5322-24 23 cm / 9"

Full curve
3 x 16 mm bite
Laminectomy
Rongeur

Marquard



INS-23-5321-24

Curved
3 x 16 mm bite
Laminectomy
Rongeur

INS-23-5325-20 20 cm / 8"

Kleinert-Kutz

Delicate



INS-23-5330-15 15 cm / 6"

2 x 13 mm bite
Synovectomy
Rongeur
Slight curve



INS-23-5331-15

2 x 13 mm bite
Synovectomy
Rongeur
Slight curve



INS-23-5335-15 15 cm / 6"

3 x 8 mm bite
Full curve
Delicate

Kleinert-Kutz

Delicate

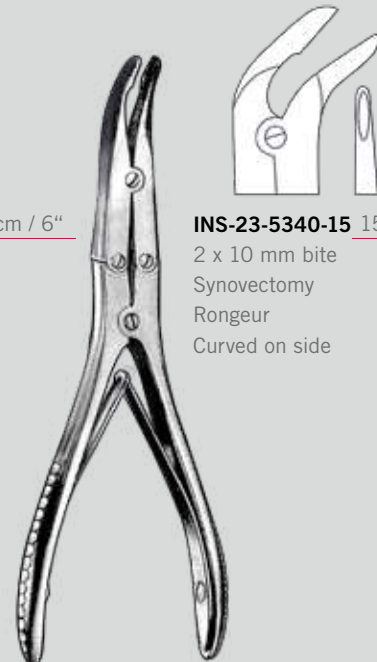

INS-23-5340-15 15 cm / 6"

2 x 10 mm bite
Synovectomy
Rongeur
Curved on side

Liston



INS-23-5420-14 14 cm / 5½"
Straight



INS-23-5425-14
Curved



INS-23-5420-17 17 cm / 6¾"
Straight



INS-23-5425-17
Curved



INS-23-5420-19 19 cm / 7½"
Straight



INS-23-5425-19
Curved



INS-23-5420-22 22 cm / 8¾"
Straight



INS-23-5425-22
Curved

Cleveland



INS-23-5435-15 15 cm / 6"

Cleveland



INS-23-1040-15 15 cm / 6"
INS-23-1040-17 17 cm / 6¾"

Böhler



INS-23-5480-14 14.5 cm / 5¾"



INS-23-5485-17 17 cm / 6¾"

Mc Indoe

Ruskin-Liston

Liston



INS-23-5490-17 17.5 cm / 7"



INS-23-1051-18 18.5 cm / 7¼"
Straight



INS-23-1052-18
Curved

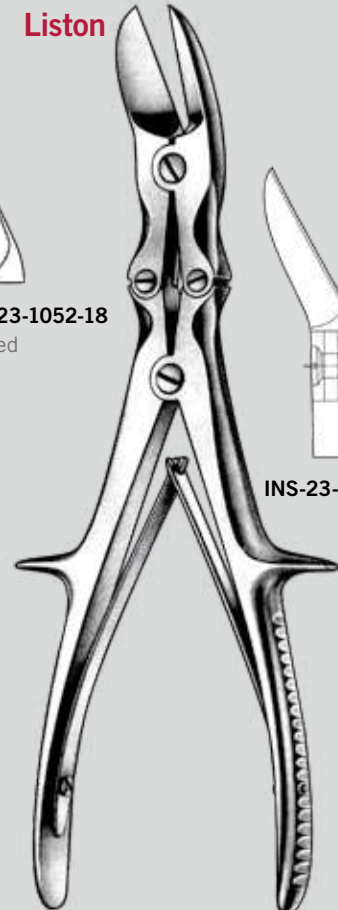

INS-23-5495-24 24 cm / 9½"

Wire Twister, TC

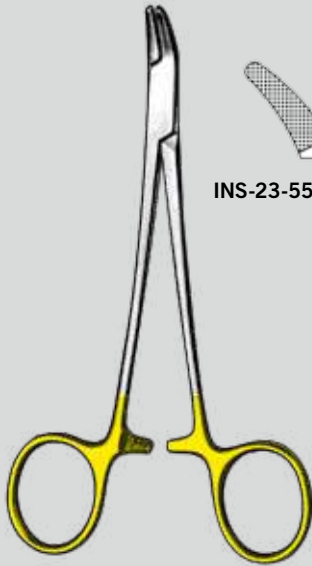

INS-23-5525-15T 15.5 cm / 6"

Corwin, TC



INS-23-5530-16T 16 cm / 6¼"

Wire Twister, TC



INS-23-0601-15T 15 cm / 6"

Wire Twister, TC

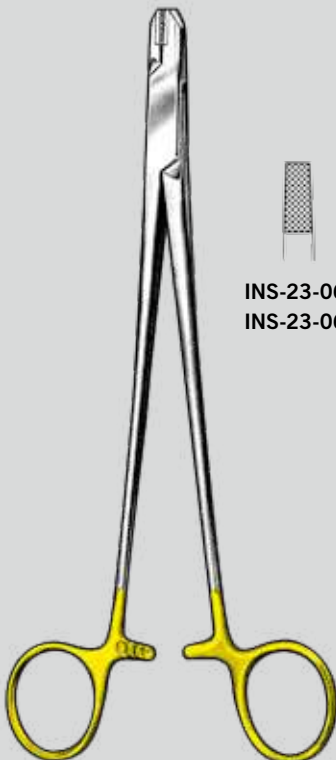

INS-23-0621-18T 18 cm / 7"
INS-23-0621-20T 20 cm / 8"

Berry, TC



INS-23-5535-18T 18.5 cm / 7¼"
INS-23-5535-20T 20 cm / 8"

Wire Twister/Cutter, TC



INS-23-5505-17T 17 cm / 6¾"
Holding forceps for cerclage wire, with lateral jaws to avoid wire slipping off

Wire Twister, TC



INS-23-5545-15T 15 cm / 6"
Wire tightening pliers
ligature pliers

Flat Nose Pliers, TC



INS-23-5565-18T 18 cm / 7" Parallel grip
INS-23-5566-18T Parallel grip

INS-23-5567-18T 18 cm / 7" Parallel grip

Flat Nose Pliers, TC

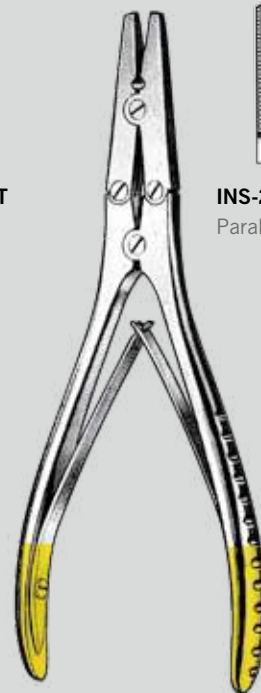

INS-23-5570-18T 18 cm / 7" Parallel grip
INS-23-5571-18T Parallel grip

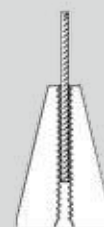



Hakstock

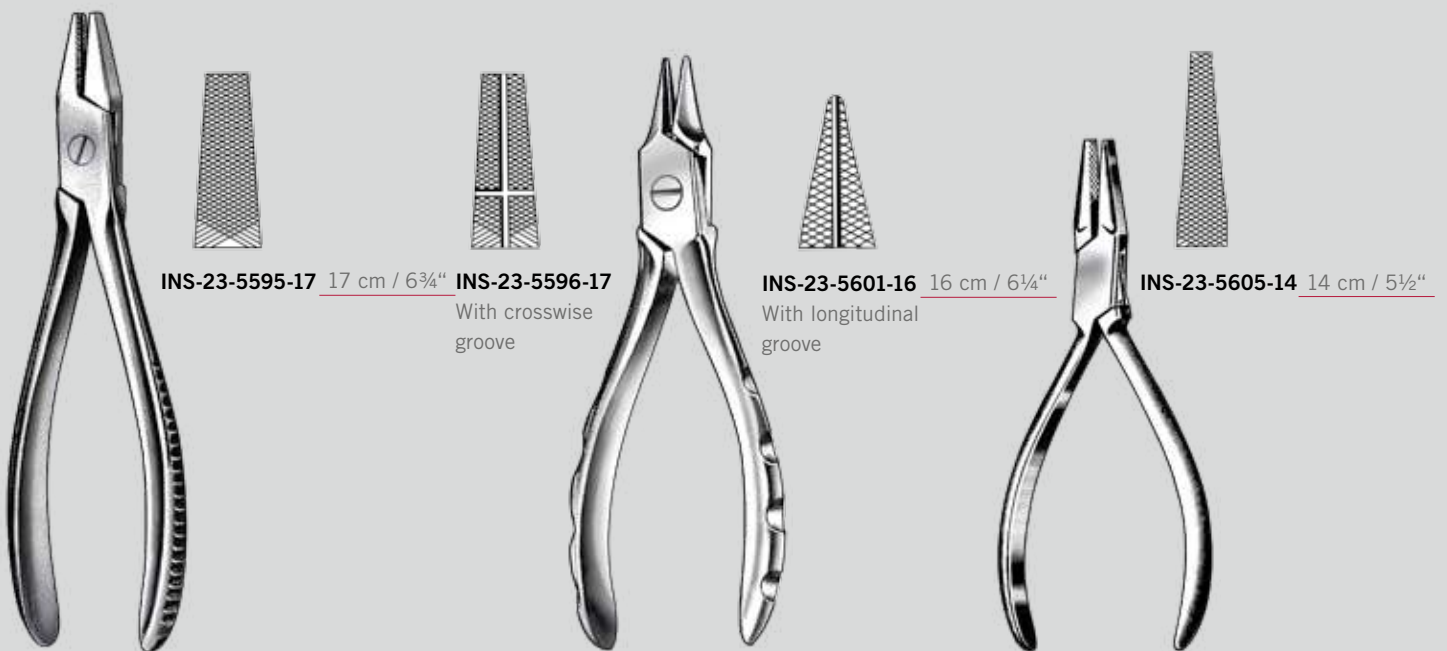



INS-23-5695-20 20 cm / 8"
Slip joint plier
10 mm tip
Maximum opening 2"



INS-23-5655-00
Wire tightener



INS-23-5710-13 13 cm / 5¼"
INS-23-5710-17 17 cm / 6½"

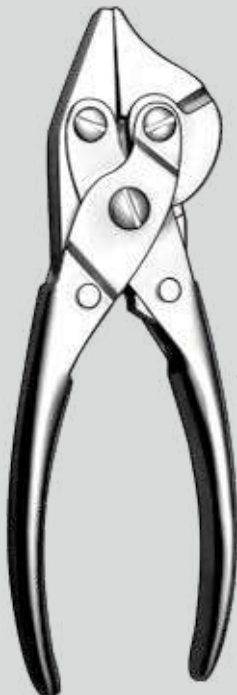

INS-23-5715-17 17 cm / 6½"
INS-23-5715-12 12.5 cm / 5"
With side cutter

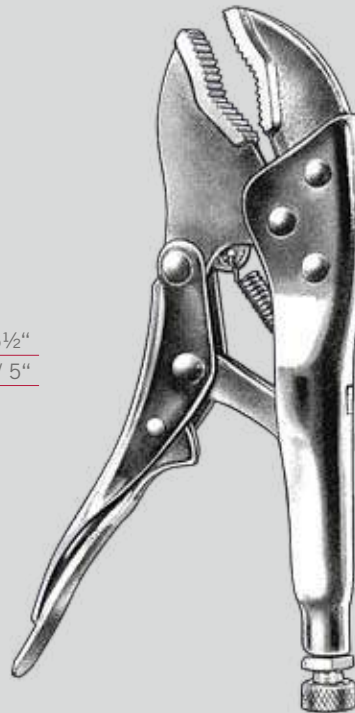

INS-23-5720-18 18 cm / 7"

Diamant



INS-23-5770-16 16 cm / 6¼"



INS-23-5775-16 16 cm / 6¼"
for soft wires up to \varnothing 2.5 mm
for hard wires up to \varnothing 2.0 mm

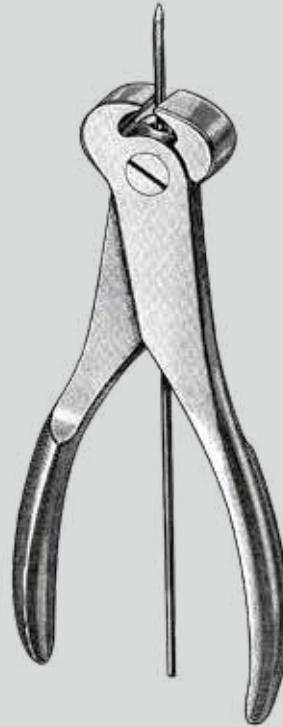

INS-23-5780-00 16 cm / 6¼"
for soft wires up to \varnothing 2.4 mm
for hard wires up to \varnothing 1.8 mm

Wire Cutter, TC



INS-23-5785-16T 16 cm / 6¼"
INS-23-5785-18T 18 cm / 7"
INS-23-5785-20T 20 cm / 8"

Wire Cutter, TC



INS-23-5790-14T 14 cm / 5½"
INS-23-5790-16T 16 cm / 6¼"
INS-23-5790-18T 18 cm / 7"

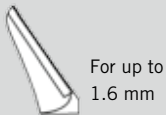

Wire Cutter, TC



INS-23-5795-22T 22 cm / 8¾"
for soft wires up to \varnothing 2.6 mm
for hard wires up to \varnothing 2.2 mm



Wire Cutter, TC



INS-23-5801-14T 14 cm / 5½"
INS-23-5801-16T 16 cm / 6½"
INS-23-5801-18T 18 cm / 7"
INS-23-5801-22T 22 cm / 8¾"
for soft wires up to \varnothing 3 mm
for hard wires up to \varnothing 2.2 mm



Wire Cutter, TC
Front and Side

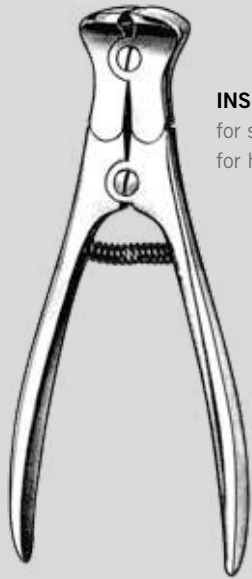

INS-23-5805-15 15 cm / 6"
for soft wires up to \varnothing 2.0 mm
for hard wires up to \varnothing 1.2 mm



INS-23-5810-24 24 cm / 9½"



INS-23-5815-18T 18 cm / 7"
for soft wires up to \varnothing 2 mm
for hard wires up to \varnothing 1.5 mm



Front Pin Cutter, TC

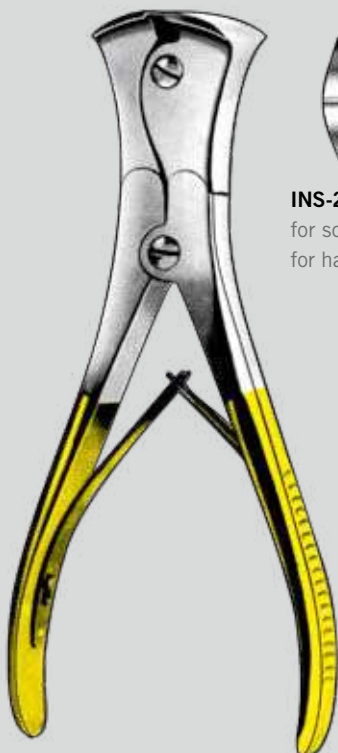

INS-23-5825-22T 22 cm / 8¾"
for soft wires up to \varnothing 3.5 mm
for hard wires up to \varnothing 2.5 mm



Wire Cutter, TC

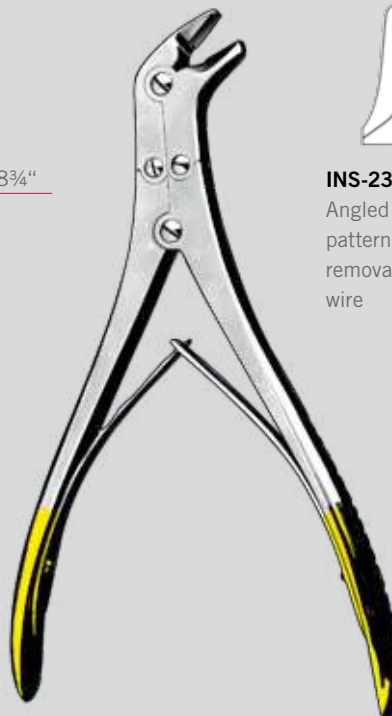

INS-23-5820-17T 17 cm / 6¾"
Angled slender
pattern for wire
removal (for soft
wire)



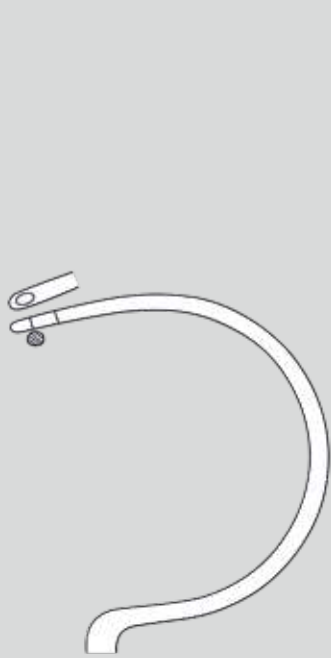

INS-23-5910-27 27.5 cm / 10¾"
Fig. 3

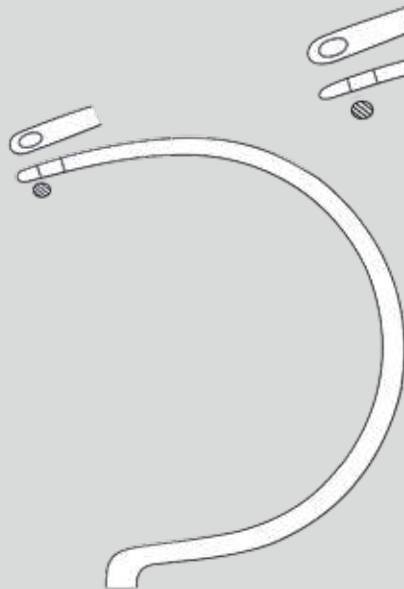

INS-23-5910-28 28.5 cm / 11¼"
Fig. 2

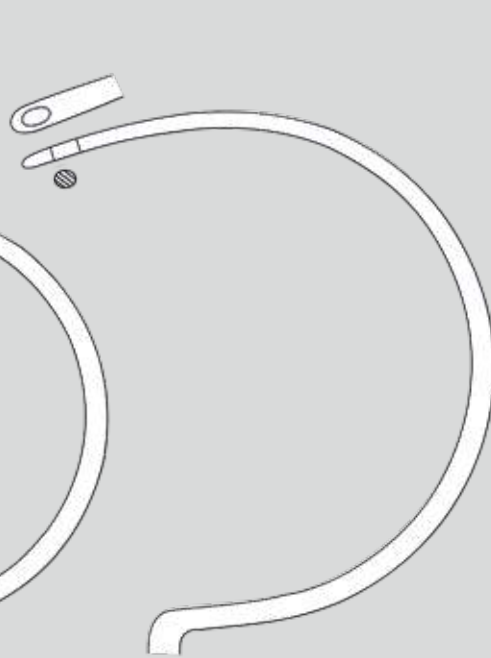

INS-23-5910-30 30.5 cm / 12"
Fig. 1



INS-23-5940-00
Cerclage wire passer



INS-23-5945-00
ø 45 mm

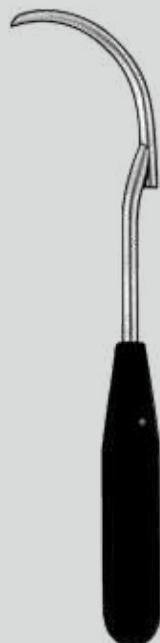

INS-23-5950-00
ø 70 mm



INS-23-6050-22 22 cm / 8¾"

Bunnell



INS-23-3490-24 24 cm / 9½"

Ralk



INS-23-3495-00
Normal shaft

INS-23-3496-00
Long shaft

Jacobs



INS-23-3501-00
Small
Stainless steel

INS-23-3502-00
Large
Stainless steel



INS-23-3505-00
Key for jacobs chuck
Stainless steel

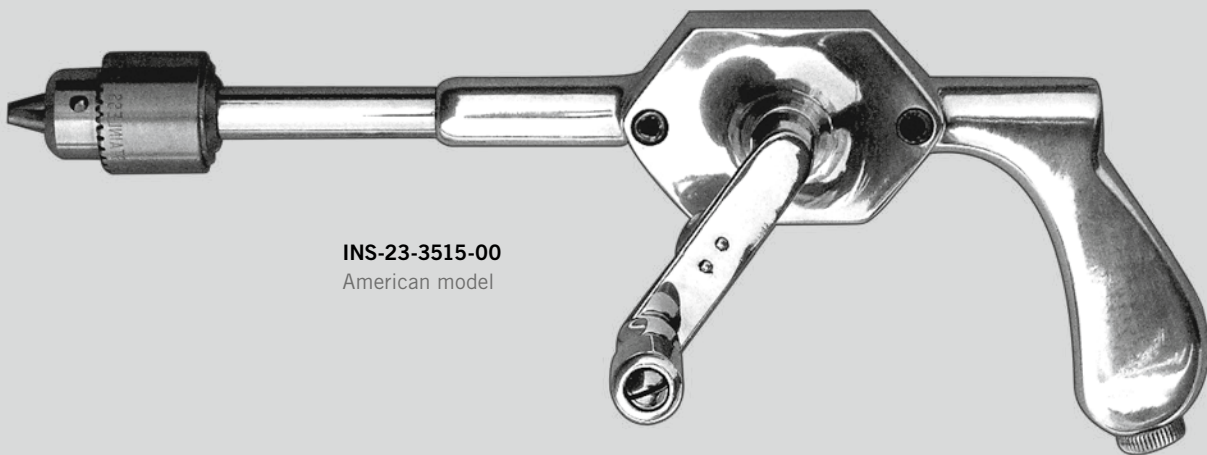

INS-23-3515-00
American model

Bone Mill



Table Spanner (used for Bone Mill)



Cutting cylinder



Cutting cylinder



Bonescraper

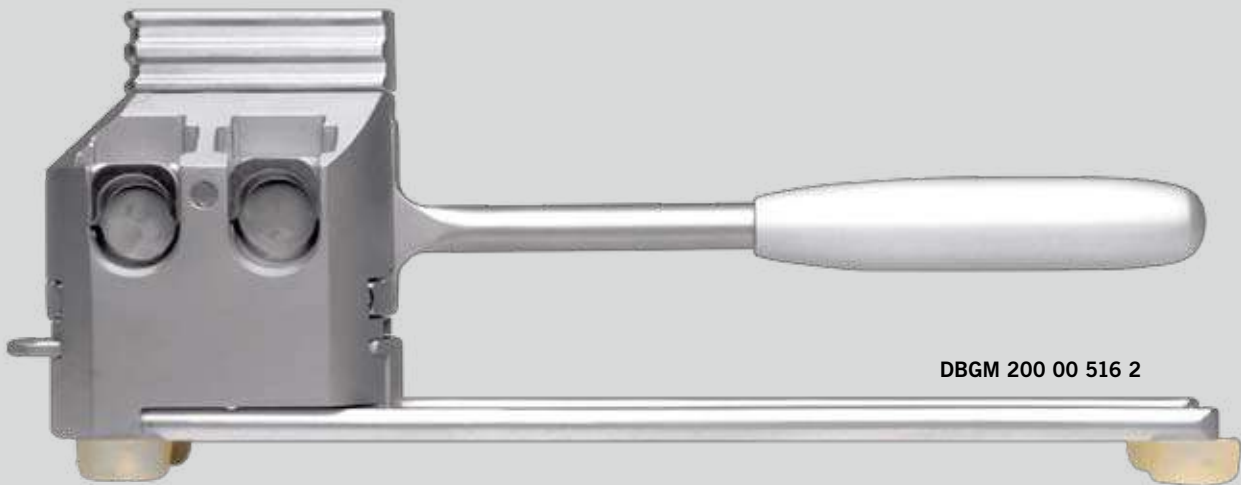

DBGM 200 00 516 2

INS-52-0328-1602 28cm / 11"

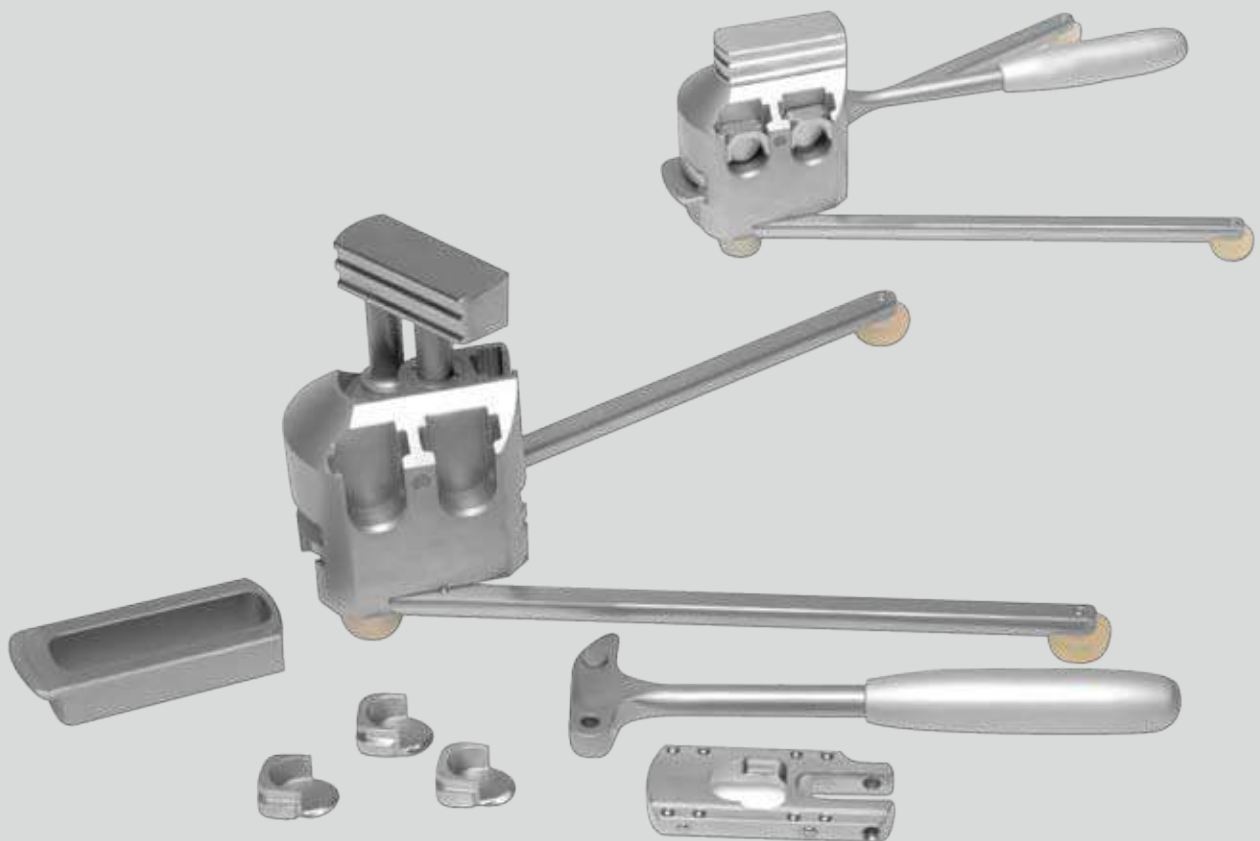

Contents list

Scalpel Handles

Scalpel Handles	04-05
-----------------	-------

Forceps

Artery Forceps	06
Artery Forceps, Delicate	07-08
Delicate Artery Forceps	09
Artery Forceps	10-11
Tissue, Organ Grasping Forceps & Angiotribes	12
Towel Forceps	13
Cotton Swab Forceps – Sponge Forceps	14

Dressing & Tissue Forceps

Dressing and Tissue Forceps	15-16
Micro Forceps, Splinter Forceps	17
Dissecting Forceps	18

Scissors

Operating Scissors	19-21
Dissecting Scissors	22-23
Dissecting Scissors, Fino-Line	24
Fine Operating Scissors	25
Fine Operating Scissors & Ligature Scissors	26
Operating Gum & Ligature Scissors	27
Micro Scissors	28
Bandage Scissors	29
Scissors with Tungsten Carbide Inserts	30-33

Needle Holders

Needle Holders	34-40
----------------	-------

Retractors

Retractors	41-42
Hooklets	43
Micro Hooklets, Skin Hooks	44
Saddle Hooks, Hooklets	45

Contents list

Retractors

Hooklets	46
Wound Spreaders, Self-retaining	47
Retractors	48
Wound Spreaders, Self-retaining	49
Retractors	50
Abdominal Retractors	51

Orthopedic

Mallets	52-58
Bone Files, Bone Levers	59
Nasal Rasp, Bone Files	60
Bone Files	61-62
Wire Saws	63
Bone Curettes	64
Bone Osteotomes Chisels And Gouges	65
Bone Osteotome Chisels	66
Elevators	67
Periosteal Elevators	68
Bone Levers	69-70
Bone Holding & Reduction Forceps	71-75
Bone Holding Forceps	74-78
Bone Holding Clamps, Traction Bar	79
Bone Holding Clamps	80
Bone Rongeur Forceps	81-87
Bone Cutting Forceps	88-89
Wire Twisting Forceps, Tungsten Carbide	90
Wire Tightening Pliers, Flat Nose Pliers, Tungsten Carbide	91
Wire Twister, Flat Nose Pliers, Wire Cutting Pliers	92
Wire Twister & Wire Cutting Pliers	93
Wire Cutting Pliers	94-95
Bone Wire Guides	96
Hand Drill and Chuck	97
Bone Mill, Cutting cylinder, Table Spanner	98
Bonescraper	99

Important Notice:

This is our General Catalogue which remains our exclusive property. Change of design and pattern reserved. Re-printing, even in parts, is not permitted. All business is subject to our General Terms of Sale. As of January 2010

